

03/2024

VM VERLAG
Cologne /Germany



EXTRUSION INTERNATIONAL

USA

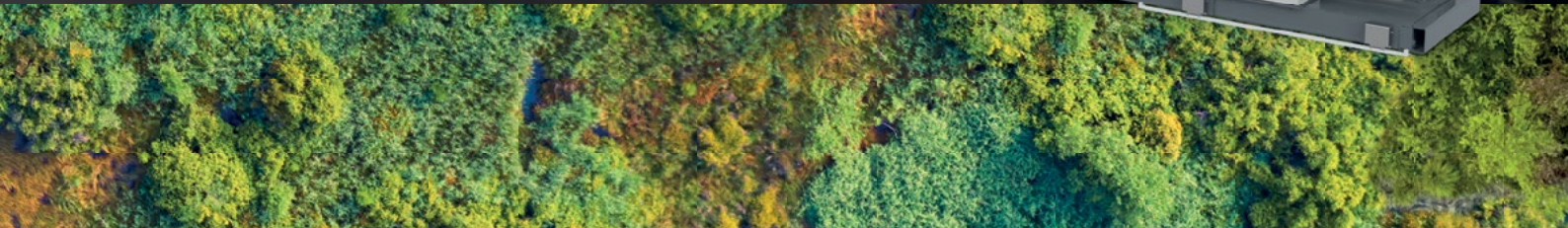
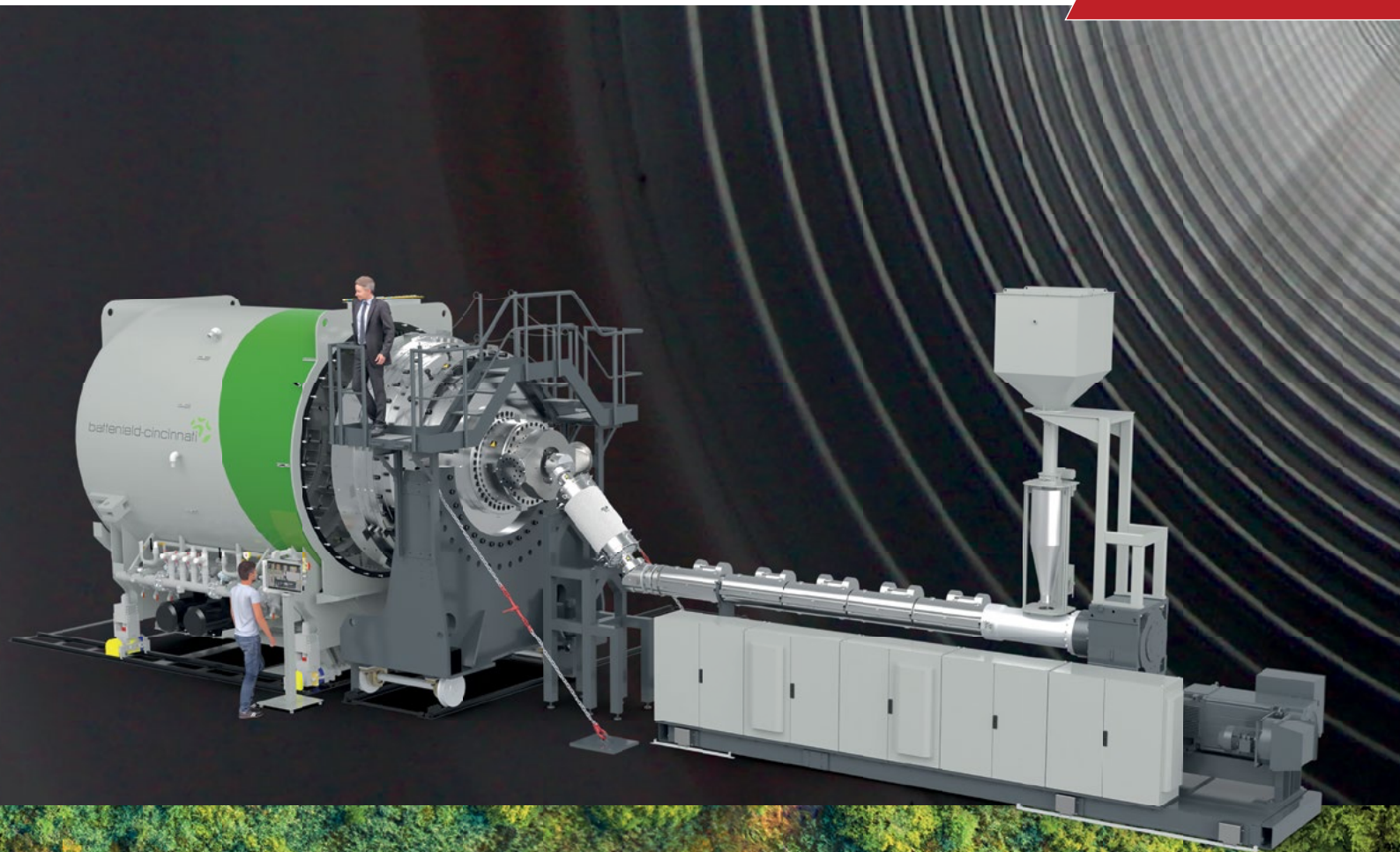

PO Pipe extrusion 2,7m line

- Output capacity up to 2500kg/h
- Die head with optimelt system
- Newly designed vacuum & cooling tanks

www.battenfeld-cincinnati.com

Process engineering for
efficient plastics extrusion
of tomorrow.

battenfeld-cincinnati



a Davis-Standard Company

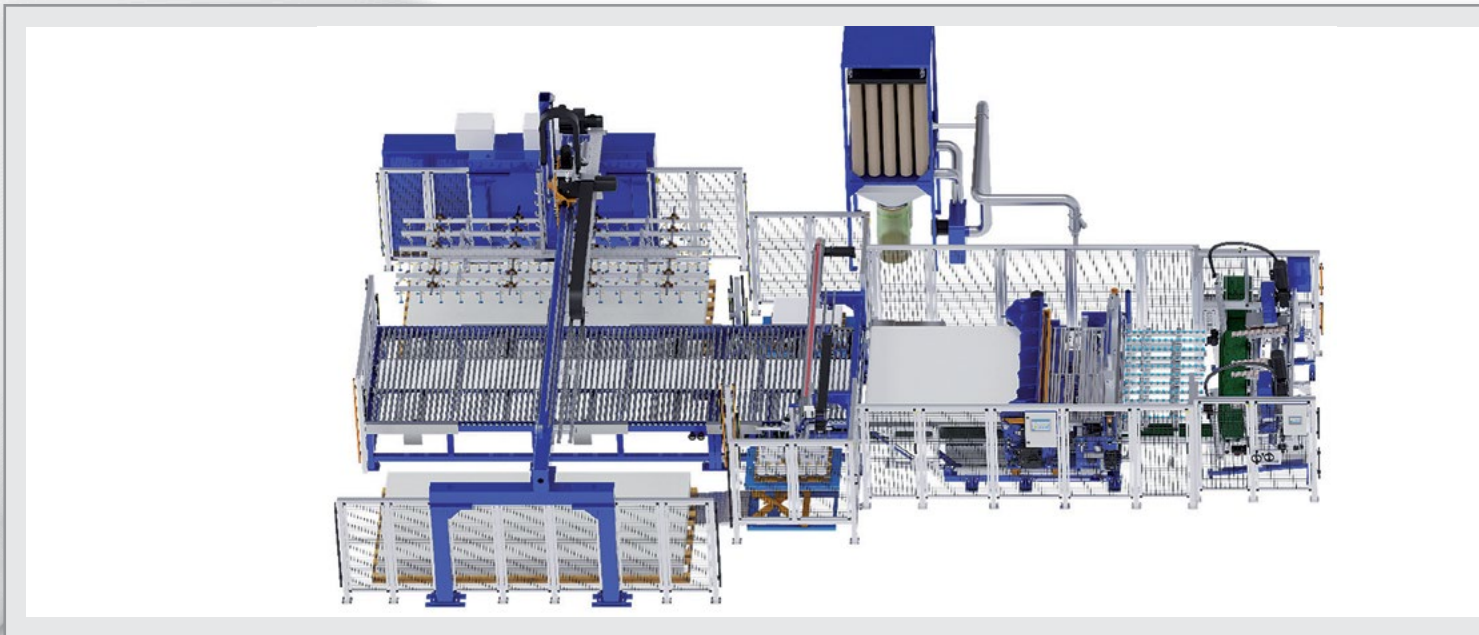

Plate Stacking Machine

for automatic depositing of your production plates on transport pallets or trolleys.

Optional available with:

- Additional stacking places
- Spreading device of sheets side by side
- Separation of consecutive panels for simultaneous stacking



Cross Cutting Combination

enables optional sawing or cutting in one machine.

Optional available with:

- Hydraulic driven scissor
- Electric driven scissor
- Cross Cut Mill instead of saw
- Cutting angle adjustment



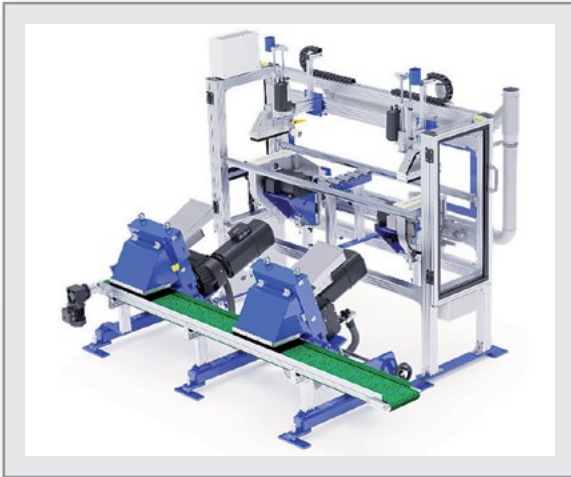

Edge Trimming Saw & Trim Strip Chopper

an unbeatable team for longitudinal cutting of your panel and direct shredding of the resulting return material.

The machines are also offered individually with many options.

As a specialist in the field of special machine construction, we always find a solution!

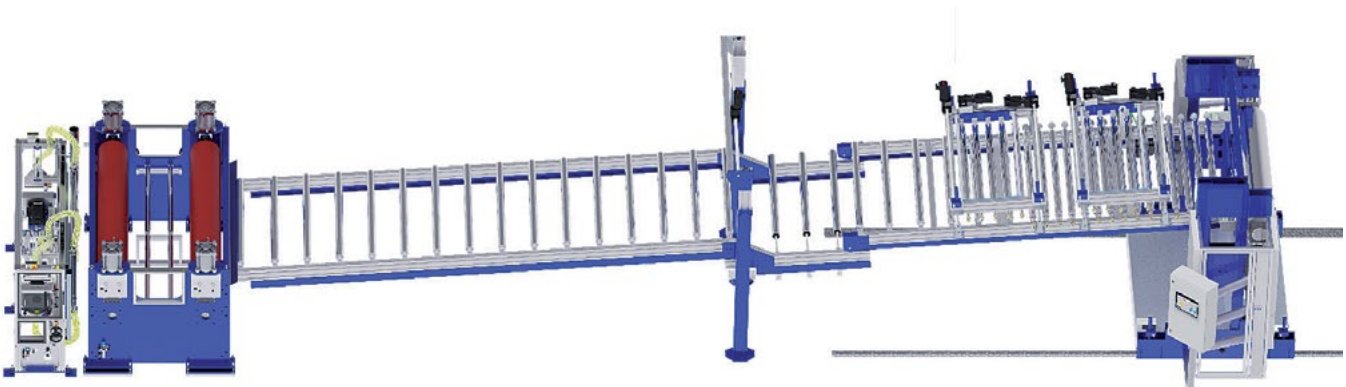

Pull Off Roller

provides precise regulation and compliance of roller speed and roller force.

Optional available with:

- Automatic material run control
- Selection of roller coatings
- Multiple Pull Off Roller version

Calender

for continuous dimensional accuracy and surface quality.

Key data:

- Throughput capacity depending on material 400 - 1300 kg/h
- Line speed 0,5 - 70 m/min
- Line pressure per roller: 100-1300 N/cm



**STEIN Maschinenbau
GmbH & Co. KG**

Wartbachstrasse 9
66999 Hinterweidenthal/Germany
Tel. (+49) (0)63 96-9215-0
Fax (+49) (0)63 96-9215-25
stein@stein-maschinenbau.de
www.stein-maschinenbau.de

CONTENTS

| | | | |
|----------------------------------------------------------------------------------------------------------------------------------------|----|----------------------------------------------------------------------------------------|----|
| Firms in this issue | 6 | Continuous Commitment to Sustainability | 30 |
| Imprint | 7 | Global Footprint Grows | 30 |
| Industry News | 8 | Investment in Startup | 31 |
| Calendar | 8 | Waste360 Teatures Op-ed | 31 |
| DKT 2024: The Catalyst for the Industry | 8 | 2023 Global Impact Report Released | 32 |
| K 2025 motto and key topics: The Power of Plastics! Green – Smart – Responsible. | 9 | Clean Sweep Claims | 32 |
| New Rep Organization | 9 | Exclusive Distributorship Announced | 33 |
| Customer Proximity Fostered | 10 | 2024 Bioplastics Market Watch | |
| Co-founder Passed Away | 10 | Report Released at NPE2024 | 34 |
| Strategic Alignment to Lead with Purpose | 11 | Analysis „End Pollution, Not Production“ Released | 34 |
| Advisory Board Confirms interpack President | 12 | Platinum Sustainability Rating by EcoVadis Earned | 34 |
| Focus on the Customer | 12 | New CEO in North America | 35 |
| Optimum Drive Design for Maximum Efficiency and Cost-Effectiveness | 13 | New President Global Services | 35 |
| New Skill Into the Family Business with the Fourth Generation | 14 | Pipe Extrusion | |
| 95th Birthday of Company Founder | 14 | Unique Large-Diameter Pipe Line Expertise – Two Record Lines Sold | 36 |
| Back to Normal Business Mode | 16 | Extrusion Technology | |
| Nomination for the German Innovation Award | 16 | Revolutionizing Fiber Optic Infrastructure – The Rise of Microduct Pipes | 37 |
| Process Simulation Enhanced by Realistic Cost Calculation | 18 | Extrusion Technology | |
| Market Study: Plastic Pipes | 18 | Sustainable Technology for the Rubber Industry Presented at DKT 2024 | 38 |
| New COF Indicator Simplifies Measuring Friction on Packaging Film | 19 | Measurement and Inspection Technology | |
| Carbon Footprint for Products and Entire Companies | 20 | ProfilControl 7 Roughness Checks Quality of Rubber Compounds | 39 |
| Joint Project Proves the Feasibility of Separating Multilayer PVDC Films from Polyolefins in Used Packaging Structures | 20 | Extrusion Technology, Recycling | |
| US Compostability Certificate for Limestone Based Bioplastic Received | 21 | Closed-Loop Recycling of HDPE – Pellets for Food Contact with OMNImax Recycling System | 40 |
| Spiderless Pipe Die for Extrusion Introduced | 22 | Profile Extrusion | |
| NPE2024 | 22 | IQ STACK – Greater Efficiency Thanks to Automated Profile Handling | 42 |
| Record-Breaking NPE2024 – NPE2024 Captivates and Inspires Global Leaders and Rising Stars to Shape the Future of the Plastics Industry | 23 | Pipe Extrusion | |
| Recycling Innovation Lowers Melt Temperature and Saves Energy | 23 | New Solution for PVC Pipe Extrusion | 44 |
| Smart Solutions for Plastics | 23 | Recycling – Case Study | |
| Recycling and Compounding | 24 | Efficient Cable Recycling | 45 |
| New Rotary Die and Cam Lock Design | 24 | Recycling – Case Study | |
| Featured at NPE | 26 | Turkish Plastics Recycler Enters PET Bottle-to-Bottle Market | 47 |
| Advanced C:GRAN Series Introduced at NPE2024 | 27 | Shredding Technology – Case Study | |
| Industry News USA | 28 | Shredder Quartet Goes to the Netherlands | 48 |
| Cutting-Edge Factory Automation Solutions Launched at NPE2024 | 28 | Quality Management – Interview | |
| Over 21,000 Meals Packed for Charity at NPE2024 | 29 | „Our solutions optimize quality assurance – efficiently and sustainably“ | 50 |
| Building Business in a Competitive Market | 29 | CHINAPLAS 2024 | |
| | | Perfect Conclusion to CHINAPLAS's Return to Shanghai | 52 |
| | | Plastpol 2024 | |
| | | Successful Trade Fair Conclusion | 54 |



37

Microduct pipes are small, flexible conduits designed to house optical fibers, protecting them from environmental factors while facilitating easy installation and maintenance. Tecnomatic's groundbreaking lines, specifically engineered for microduct pipe production, have set new standards in terms of speed, efficiency, and quality



39

A perfect rubber profile starts with a perfect compound. With the ProfilControl 7 Roughness inspection system from PIXARGUS it is possible check the quality of rubber compounds in a straightforward, time-saving and efficient way



40

If treated with the Gneuss "Super Clean Process", bottle flakes can be reprocessed back into a bottle cap, thus closing the recycling loop. The Gneuss OMNImax recycling system used in this process has undergone multiple challenge tests and has been awarded several food contact approvals/LNOs



42

In the fast-moving world of industrial development, innovation is more important than ever – while Exelliq's iQ STACK is set to revolutionize profile extrusion: the elegant and ultramodern stacking system integrates seamlessly into existing extrusion lines and paves the way towards fully automated production process

Lockerer Recycling specialises in waste cable recycling. Thanks to the recycling concept developed in-house, the company can achieve the highest possible copper recovery at low processing costs. The company trusts in Lindner's recycling expertise and uses a Polaris 2800 with rotor cooling



45



48

For the processing of post-consumer waste (PE) and flowerpots (PP), the Veolia Nederland subsidiary Aufderhaar Kunststoff Recycling uses no less than four large WEIMA shredders for secondary shredding. The resulting regranulate is then reused for the production of packaging material

Index of Advertisers, companies and fairs referred in this issue

| | | | |
|--------------------------|--------------------|-----------------------|----------------------|
| Adsale | 52 | Lindner-Recyclingtech | 45 |
| battenfeld-cincinnati | Outside Cover, 36 | Messe Düsseldorf | 9 |
| Baumüller | 13 | motan | 7 |
| Baumüller-Nuermont | 35 | Muller Technology | 28 |
| Bausano | 44 | NGR | 27 |
| BST | 50 | NPE2024 | 23 |
| Busch | 14 | Orion | 34 |
| CCA | 13 | Pixargus | 39 |
| Ceresana | 18 | PlasMec | 11 |
| Chemovator | 31 | PLASTICS | 23, 29, 31, 32, 34 |
| Chinaplas | 52 | Plastpol | 54 |
| Coperion | 24 | PTi | 33 |
| Davis-Standard | 30, 35 | Reifenhäuser | 14 |
| DKT 2024 | 8 | SIGMA Engineering | 18 |
| EREMA | 23 | Sikora | 17 |
| Exelliq | 42 | Smart-Extrusion | Inside Back Cover |
| Extreme Coatings | 30 | SKZ | 20 |
| FIMIC | 11 | Starlinger | 47 |
| Flender | Outside Back Cover | Stein Maschinenbau | Inside Front Cover+3 |
| GAIA | 21 | Syensqo | 20 |
| GINDUMAC | 10 | Targi Kielce | 54 |
| Gneuss | 40 | Tecnomatic | 37 |
| Guill Tool & Engineering | 9, 22, 26 | TOMRA | 20 |
| Heartland Industries | 31 | TROESTER | 19, 38 |
| Herbold Meckesheim | 24 | Vecoplan | 12 |
| Herrmann Ultraschall | 10 | VM Verlag | Inside Back Cover |
| interpack | 12 | Vetaphone | 29 |
| K 2025 | 9 | WEIMA | 48 |
| Kautex | 16 | Zumbach | 15 |
| Leibinger, Paul | 16 | | |

MEDIA DATA 2024

MAGAZINE · WEBSITE · NEWSLETTER

EXTRUSION

EXPERT MEDIA ON PLASTICS EXTRUSION



03/2024

VM VERLAG
Cologne / Germany

EXTRUSION INTERNATIONAL



The Extrusion International Magazine
is published bimonthly by VM Verlag GmbH.
P.O.Box 501812, D- 50879 Cologne, Germany

EDITOR

Bettina Jopp-Witt (Editor-in-chief)
T. +49 221 546 1539
redaktion@vm-verlag.com

ADVERTISING SALES

Martina Lerner
T.+49 6226 971515
lerner-media@t-online.de

Jana Bogatzke
T. +49 1556 614 9190
j.bogatzke@vm-verlag.com

Bella Eidlin
T. +49 152 29907895
b.eidlin@vm-verlag.com

Tanja Bolta
t.bolta@vm-verlag.com
+49 15205626122

ADMINISTRATION

Alla Kravets
T. +49 2233 949 8793
a.kravets@vm-verlag.com

PRINTING

maincontor GmbH
Dr.-Gammert-Str. 13a,
63906 Erlenbach, Germany
T.: +49 937294810811
www.maincontor.de,
info@frankhohmann.com

SALES REPRESENTATIVES

China & Asia
octavia@ringier.com.hk,
T. +852-9648-2561
maggieliu@ringiertrade.com,
T. +86-13602785446

Tokyo PR Inc. (Japan)
T. +81 (3) 3273-2731
extrusion@tokyopr.co.jp

Reprints, Translation etc

No part of this publication may be reproduced,
stored in a retrieval system, or transmitted, in any form
or by any means, electronic, mechanical, photographic,
recording or otherwise, without prior permission of
the publisher.

www.smart-extrusion.com



motan

GRAVICOLOR

These gravimetric dosing and
mixing units are designed for
injection, blow moulding and
extrusion and provide through-
puts up to 2200 kg/h.



ZERO LOSS

www.motan.com

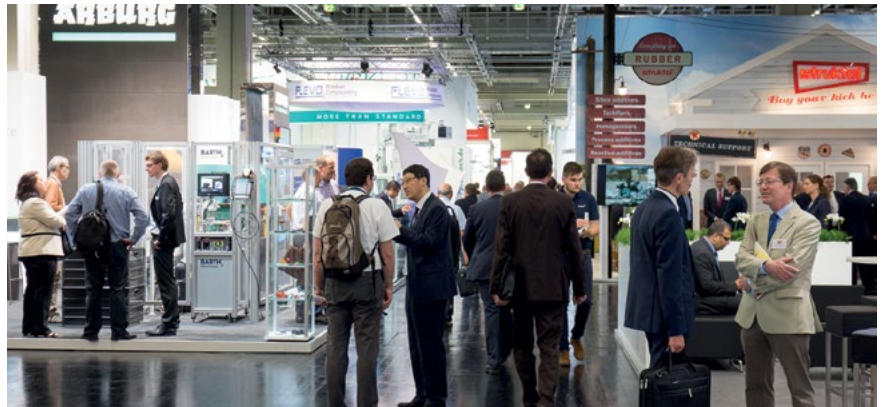

PETCORE EUROPE Therforming

Conference 2024
25 – 26 June 2024-05-06
Granada / Spain
www.petcore-europe.org

Fachpack

24 - 26 September 2024
Nuremberg / Germany
www.fachpack.de

Plast Eurasia 2024

04 - 07 December 2024
Istanbul / Turkey
plasteurasia.com

Solids Dortmund

09 - 10 October 2024
Dortmund / Germany
www.solids-dortmund.de

Fakuma 2024

15 - 19 October 2024
Friedrichshafen / Germany
www.fakuma-messe.de

ICE Europe 2025

11 - 13 March 2025
Munich / Germany
www.ice-x.com

PLASTIMAGEN

11 – 14 March 2025
Mexico City / Mexico
www.plastimagen.com.mx/es

K 2025

08 - 15 October 2025
Düsseldorf / Germany
www.k-online.de

interpack 2026

07 - 13 May 2026
Düsseldorf / Germany
www.interpack.de

Interplas 2026

02 - 04 June 2026
Birmingham / United Kingdom
www.interplasuk.com

DKT 2024: The Catalyst for the Industry

■ From July 1st to 4th, 2024, the DKT 2024 will once again open its doors in Nuremberg after two years. Under the patronage of the German Rubber Society (Deutsche Kautschuk-Gesellschaft), this event, consisting of a scientific conference, a trade exhibition, and a diverse program, promises to be a highlight for the rubber and elastomer industry.

The conference of DKT 2024 promises to be a forum for knowledge exchange and innovation. With an extensive program of over 140 presentations from 16 countries and 10 renowned keynote speakers, the latest developments, and trends from Circular Economy to Automation and Future Mobility will be presented. Special forums such as the TPE Session and the Educational Symposium provide a platform for in-depth discussions and knowledge exchange.

The trade exhibition, spanning an area of 7,700 m², hosts over 250 companies from the rubber and elastomer industry. These companies showcase their products and innovations at the exhibition grounds in Nuremberg. A particular highlight is the Chinese Pavilion in Hall 8, which underscores the international diver-

sity of the event. The Science Campus offers a unique opportunity to explore research works and results from renowned institutions.

The framework program of DKT 2024 begins with a special kick-off: the traditional Welcome BBQ Evening in the Messepark. This evening serves not only as a welcome for all participants but also provides a relaxed atmosphere for informal conversations and networking to prepare for the upcoming days of the conference and trade exhibition. The Welcome BBQ Evening is a key part of the program, offering participants an opportunity to connect and exchange ideas.

In addition to this introductory evening, DKT 2024 features a diverse framework program that includes various award ceremonies. These include recognition for outstanding individuals and innovative products, as well as the Best of Party, which acknowledges the outstanding achievements of exhibitors and students alike. Additionally, the Recruiting Day provides companies with the opportunity to meet potential talents and introduce themselves.

➔ www.dkt2024.de



K 2025 motto and key topics: *The Power of Plastics! Green – Smart – Responsible.*

■ Earlier this year the committees of K 2025 chose the motto for the coming K in Düsseldorf, from 8 to 15 October 2025. It consists of one slogan and three core messages, all focusing on the key topics of K in 2025:

The Power of Plastics! Green – Smart – Responsible.

- Shaping the circular economy
- Embracing digitalization
- Caring about people

The slogan reflects the current values and goals of the industry mirrored by the trade fair. "The Power of Plastics!" underscores the indisputable role that plastics play in various sectors of industry, ranging from medical device technology and automotive to packaging solutions. Plastics are an indispensable component of many industries, make a significant contribution to innovations and progress and are essential to designing a sustainable future. "Green – Smart – Responsible" is synonymous with the sector's commitment to act

sustainably, smartly and responsibly in plastics production and handling.

The additional core messages focus on the following three key topics:

- Shaping the circular economy:

The sector is increasingly based on a sustainable circular economy that promotes the re-use, recycling and reduction of plastic waste.

- Embracing digitalisation:

The companies operating in the plastics and rubber industry are aware of the transformative power of digitalisation and employ more and more digital technologies to boost the efficiency of their machines and products and to drive innovations.

- Caring about people:

The sector is aware of its social responsibility to protect the environment. Responsible handling of resources is in focus here. At the same time, the sector increasingly promotes young talents and creates future prospects for young profes-

sionals in the plastics and rubber industry.



The World's No. 1 Trade Fair
for Plastics and Rubber
8-15 OCTOBER 2025
Düsseldorf, Germany
k-online.com

sionals in the plastics and rubber industry.

K 2025 invites its exhibitors, experts, multipliers and interested parties from around the world to follow its motto and join forces to shape the future of the plastics and rubber industry.

➔ www.k-online.de

New Rep Organization

■ Guill Tool, the global leader in extrusion tooling, hires a new Rep Organization & promotes Rob Peters to General Manager.

Guill recently announced EuroDev as their new European sales representative company. They will offer the full line of Guill products across Europe, excluding the UK. Padraic Lunn Enterprises Ltd continues to represent Guill in the UK.

Since its establishment in 1996, EuroDev has been the preferred business development partner of more than 500 North American firms. Their team consists of over 75 highly skilled multilingual professionals whose aim is to help North American companies map out expansion strategies in an increasingly complex marketplace. The company's sales outsourcing includes market research, entry strategy, lead generation and sales.

Padraic Lunn has worked since 1990 in the medical device ex-



Rob Peters

trusion industry in Ireland. With more than 16 years in precision extrusion, Padraic Lunn offers a full range of extrusion machinery and consultancy for all extrusion processes with a strong emphasis on tubing, wire, pipe and profile

applications. The firm represents extrusion equipment companies in the UK, Ireland and other parts of Europe. Furthermore, Padraic provides customized extrusion training programs which are based on a customer's specific process requirements.

In other news at Guill, Rob Peters has been promoted to General Manager. Rob is a graduate of Cornell University, obtaining his Bachelor of Science in Mechanical Engineering and Master of Engineering in Aerospace Engineering. He has worked for a 8 years at Guill, starting off as an R&D Manager, transitioning to Business Intelligence/R&D Manager, then Director of Technology. Rob is now responsible for various operations at Guill and reports directly to company ownership.

Guill Tool & Engineering
➔ www.guill.com

Customer Proximity Fostered

■ GINDUMAC is expanding its platform technology with the new myGINDUMAC customer portal. The company's aim is to make the entire process of selling and purchasing machines more transparent, efficient, and digital.

In the current version, customers can track their projects online and are informed about project progress and incoming payments in real time via status messages. The customer portal is integrated into the existing online platform and is accessible for registered users.

In addition to project management features, the personalized user accounts allow input processes on the platform, in sales and quotation requests, to be carried out with higher convenience.

Benedikt Ruf, Co-CEO of GINDUMAC: "With myGINDUMAC, we are using digital technology to create a new level of customer proximity that simultaneously creates transparency and increases efficiency. By introducing the customer portal, we are visibly underlining our claim to make transaction management in the purchase and sale of used machines as simple as possible."

As a technology-driven company, GINDUMAC pursues a minimum viable product strategy. For the launch of the customer portal, the used machinery dealer is focusing on a beta version that will be gradually developed with new features in line with customer feedback. The plan for 2024 is to map the entire process chain for users, from machine evaluation to purchase and logistics processing through to project completion.

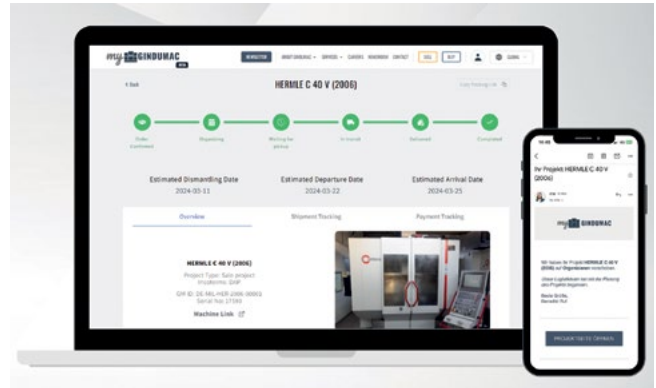

With the myGINDUMAC customer portal, GINDUMAC optimizes transparency and efficiency in the transaction management of used machines

Daniel Kaiser, Co-CEO of GINDUMAC: "Global transactions with used machines are complex. We make this complexity simple for our customers. With myGINDUMAC, we now have the right tool to ensure that digital and personal communication in project management can be even more customer-centric."

Access to myGINDUMAC is currently available to selected customers and will be open for all customer segments with new functionalities from initial contact to project completion in the course of 2024.

GINDUMAC

www.gindumac.com
www.gindumac.com/my

Co-founder Passed Away

■ Herrmann Ultraschall mourns the loss of Ingeborg Herrmann, who died on April 25. In addition to her defining role in the development of the family business, she was characterized by her exemplary local charity.

Ingeborg Herrmann has been responsible for office management and financial accounting for 40 years: from a small start-up to a world market leader in ultrasonic welding, she has accompanied and shaped the history of Herrmann Ultraschall.

Together with her husband Walter Herrmann, she founded the company in 1961. Her firm belief in the company's vision, especially in the difficult early years with no financial reserves and a barely known technology, has always been a cornerstone.

With growing success, she felt the need to give something back to society. This is why she established the charitable Walter and Ingeborg Herrmann Foundation in the early 2000s. The promotion of education was particularly important to her throughout her life. This manifested itself in her significant involvement in the founding of a Christian secondary school in Pforzheim, Germany, which began operating as "Ingeborg Herrmann School" in September 2022, carrying on her legacy.

With the passing of Ingeborg Herrmann, the company and the entire region have lost an outstanding personality who enriched the lives of those around her through her philanthropy. Her husband Walter Herrmann, son and CEO Thomas Herrmann, daughter Sabine



Ingeborg Herrmann (Photo: Herrmann Ultraschalltechnik GmbH & Co. KG)

Herrmann-Brauss and the entire staff mourn her loss and will honor her memory.

**Herrmann Ultraschalltechnik
GmbH & Co. KG**

www.herrmannultraschall.com

Strategic Alignment to Lead with Purpose

■ FIMIC has recently welcomed an exceptional addition to its team: Michael Heitzinger. With a career spanning almost two decades, Heitzinger brings a wealth of experience and a passion to transform the plastics industry by creating a blueprint for sustainable change.

Motivated by his unwavering commitment to the circular economy, Michael is prepared to start a journey of purpose and impact with FIMIC, building up an indelible mark in the field of plastics recycling.

Michael Heitzinger brings his ability to connect across borders from his international experience, as FIMIC's new OEM-Relations Manager, Michael will build strategic and operational cooperation with key players in the plastics recycling industry. Michael will maintain and expand FIMIC's global network, connections, and relationships that will drive collaborative solutions that transcend geographical boundaries to implement successful projects.

Michael joins a cross-functional team in continuous growth. "FIMIC's aim has always been to build strong unique principles and values that contribute to sustained prosperity and a positive impact on our team and customers. Principles and values that go beyond a simple work ethic, are fundamental beliefs and standards that guide the actions to build a positive culture



Erica Canaia and Michael Heitzinger

for our team members where we can thrive and have meaningful relationships with our customers," says Erica Canaia, FIMIC CEO.

FIMIC Srl
www.fimic.it

"ENSŌ" IN MIXING

looking for perfection



in equipment manufacturing for

PVC DRY-BLEND, MASTER BATCH, THERMOPLASTIC RUBBER, POWDER COATINGS, METALLIC BONDING and WPC



plasmec
 Excellence in Mixing

PLAS MEC S.R.L.
 Via Europa 79, 21015 Lonate Pozzolo (VA) - Italy
 phone +39 0331 301648 - comm@plasmec.it
www.plasmec.it

Advisory Board Confirms interpack President

■ At the constituent meeting of the Advisory Board of interpack, the Chairman and his two deputies were confirmed in their positions. The Advisory Board thus sends a clear signal of continuity and emphasises the importance of interpack's close ties with the packaging industry.

Effectively representing the interests of the industry and acting as a driving force for innovation and growth – that is the aim of interpack. The next edition will take place from 7 to 13 May 2026. On the way there, it will be actively supported by a 21-member trade fair advisory board made up of leading personalities from the packaging sector and the related process industry on the manufacturer and association side.

Markus Rustler, President and CEO of Theegarten-Pactec GmbH & Co. KG, was re-elected President and thus Chairman of the Board at the constituent meeting on 9 April 2024. Christian Traumann, Managing Director of the MULTIVAC Group and Roland Straßburger, CEO of SCHÜTZ GmbH & Co. KGaA were confirmed as Vice Presidents.

All candidates were elected unanimously.

"I would like to thank you for the trust you have placed in me and look forward to continuing this task. Our common goal is to build on the success of interpack 2023 and to further strengthen the 2026 trade fair as a trend, technology and solution platform in order to proactively meet the opportunities presented by dynamic market changes," said Markus Rustler after his re-election.

"The personal dialogue with our partners from the companies and associations is of enormous value to us - especially in times of great challenges. We are very pleased about the extraordinary expertise and the trusting cooperation in our Advisory Board," said interpack Director Thomas Dohse at the end of the meeting.

The first meeting of the trade fair advisory board marks the start of the concrete content preparation phase for the next edition of interpack in May 2026. The world's most important suppliers of packaging machinery and processing technology,



Markus Rustler

packaging materials and packaging aids, packaging production, finishing and packaging printing, marking and labelling technology as well as storage, logistics and transport technology are once again expected to exhibit. The main themes of the upcoming leading trade fair will be determined in the coming months.

Registration for interpack has been possible online since the end of March at:

► www.interpack.com/en/Exhibit/Become_an_exhibitor

Focus on the Customer

■ Daniel Kessler has been responsible for technological development at Vecoplan since March 1, 2024. In addition to product development, this includes all topics relating to digitalization and engineering. Kessler has a great deal of experience and expertise – his new role also sees him promoted to the management board.

"In order to provide customers worldwide with the best possible support, we offer, among other things, a powerful digitalization concept that we are consistently expanding and driving forward with additional services," says Daniel Kessler.

Daniel Kessler has been with Vecoplan for 19 years. He trained as

a mechatronics engineer and completed further training as a business economist and state-certified electrical engineer for automation. He gained around ten years of experience in commissioning and then switched to electrical development. Today, he can draw on many years of management responsibility, extensive process and product knowledge and a wealth of practical experience through direct customer contact. "In my new role, I not only want to develop ideas, but also achieve a real impact together with our global customers," says Kessler.



Daniel Kessler is now responsible for technological development at Vecoplan as a member of the management board (Picture: Vecoplan)

Vecoplan AG
► www.vecoplan.com

Optimum Drive Design for Maximum Efficiency and Cost-Effectiveness

■ Designing a drive system often presents engineers with a challenge: If the motor-drive combination is selected too conservatively, this leads to inefficient operation and unnecessary costs. On the other hand, if the design is too narrow, it carries the risk of operating problems and a shortened service life. To simplify the design process, Baumüller has added an innovative drive curve analysis to its ProDrive commissioning tool that can be used when developing new machines as well as for service.

The new function enables engineers to visualize the actual utilization of their drive system quickly and easily. Through the representation of the drive curve in ProDrive, it is easy to determine during the commissioning process whether the system is optimally dimensioned or whether adjustments need to be made to get the best possible performance from the components.

The drive curve combines all relevant information on the motor, converter, and control. It is an essential tool for analyzing and optimizing the drive design. ProDrive clearly displays the motor's nominal and limit curves and visualizes the drive curve dependent on the relevant operating conditions and control settings. Engineers can either enter a specific operating point or read in data from a measurement. For maximum flexibility, users can also integrate the characteristic curves of third-party motors into the tool.

Baumüller
 ► www.baumüller.com

The drive curve analysis visualizes the actual load of the drive and the relation to the nominal and limit curves

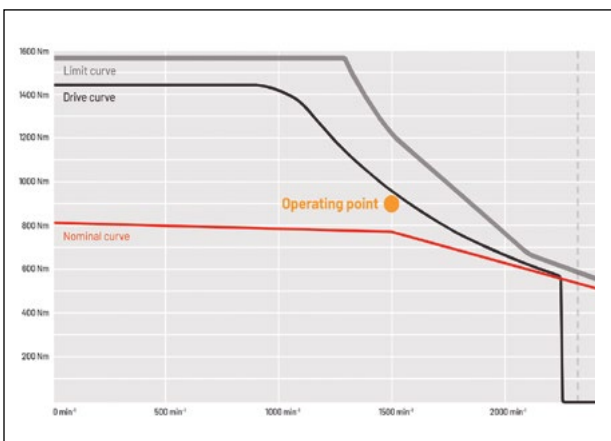



hoch5.com

CCA

The Original

Quality is our Priority

Backed by 30 years of experience, CCA develops calibration sleeves for plastic pipe extrusion:

- from Ø 12 mm up to Ø 2.400 mm pipe outside diameter
- precisely matched to the production requirements of our international customers

Rely on quality „Made in Germany“.

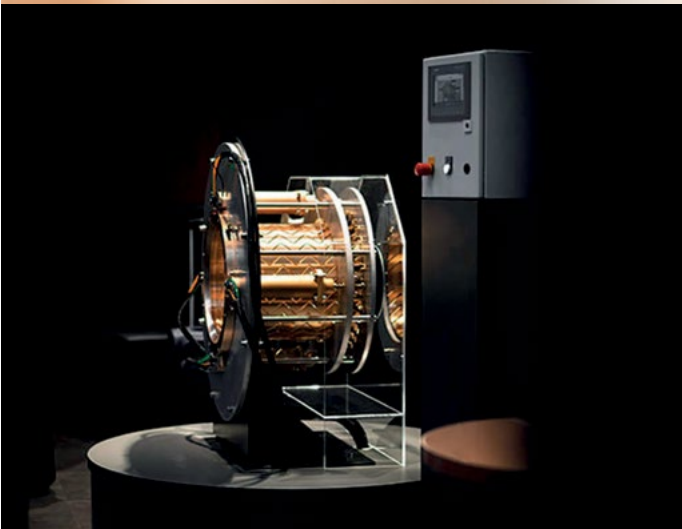

www.ccagmbh.de

New Skills Into the Family Business with the Fourth Generation

■ Jan Karnath, a nephew of Bernd Reifenhäuser (CEO) and Ulrich Reifenhäuser (CSO), is the first representative of the fourth generation to join the operational business of the Reifenhäuser Group. His start paves the way for the continuous development of the family business and reinforces the transformation from machine manufacturer to solution provider: As the company's first Chief Digital Officer, Karnath will henceforth be responsible for and steer the Group's digital transformation.

"We are delighted that our family business is now being supported by the fourth generation," says Bernd Reifenhäuser. "Jan's appointment strengthens our foundation, which is based on values such as continuity, stability and trust. At the same time, Jan and his role in the company stand for the continuous further development of the group of companies. We will continue to expand our digitalization offerings with a strong market and customer focus in line with our pioneering spirit. Jan brings with him all the skills from his previous career to manage this development responsibly."

In his new position as Chief Digital Officer, Jan Karnath is responsible for the strategic and operational development of all Reifenhäuser units whose business model is based on digital products: The tech start-up RE: GmbH, which specializes in connecting entire production facilities, AR:DEL, Reifenhäuser's digital education and learning platform, and R-Cycle, the digital product passport for sustainable packaging. In addition, Karnath is responsible for the Group's overall digital strategy: he will continue to develop the portfolio of digital products and ensure that all relevant digital initiatives are integrated into strategic planning.



From left to right: Ulrich Reifenhäuser (CSO), Bernd Reifenhäuser (CEO) and Jan Karnath (CDO) (Picture: Reifenhäuser)

Jan Karnath says: "As a shareholder, I have been observing Reifenhäuser's development for many years. I am all the more pleased that I can now actively shape the future of the family business with my expertise. Our goal is to further expand our digital portfolio and give our customers a head start in terms of efficiency, transparency and quality."

Jan Karnath has over 15 years of experience in the digital business. He studied Management in Vienna and Digital Transformation & Innovation at Stanford University. He then began his career at SAP and has since successfully led several digital companies as a board member and founder.

Reifenhäuser Gruppe
www.reifenhäuser.com

95th Birthday of Company Founder

■ Just before his birthday, Dr Karl Busch traveled to the Netherlands with his wife Ayhan to attend this year's international Busch Group Manager Meeting. The co-founder and co-owner of the world market leader, who celebrated his 95th birthday on April 20, 2024, still follows the product presentations of his company with great interest.

Together with his wife Ayhan and their children Ayla, Sami and Kaya Busch, Dr Karl Busch manages the worldwide group. In over 60 years, the Busch Group has grown to become the second largest vacuum pump manufacturer in the world. It all began as a small two-person company founded by Dr Karl Busch and his wife Ayhan in Schopfheim in 1963.

Engineer and inventor Karl Busch met his wife Ayhan during his mechanical engineering studies in Munich, where she studied dentistry. Prior to his studies, he attended and graduated from the upper secondary school in Schopfheim, while working as an apprentice mechanical fitter at the same time. In 1960, he obtained his doctorate at the Technical University of Munich (TUM) on



Dr Karl Busch with his wife Ayhan and their children Ayla, Sami and Kaya

the topic of friction and wear in water-lubricated rotary compressors. After that, he first worked at his grandfather Karl Wittig's company in Schopfheim as a design manager before he and his wife founded Dr.-Ing. Karl

Busch GmbH – today, Busch Vacuum Solutions. In 1972, the company moved to Maulburg.

When self-service supermarkets emerged in Germany in the early 1960s, many household-sized foodstuffs had to be packaged in a manner that was both hygienic and visually appealing. Dr Karl Busch developed the first vacuum pump specifically for this application: the HUCKEPACK. This is a particularly compact and robust rotary vane vacuum pump with pump stages arranged one above the other.

In April 1971, Busch founded its first overseas subsidiary in the United Kingdom and was the first German industrial company to sign a cooperation agreement for manufacturing in China in 1981. Pfeiffer Vacuum and centrotherm clean solutions have now joined forces with Busch Vacuum Solutions to form the new Busch Group.

For their outstanding entrepreneurial achievements, Dr Karl Busch, who is also honorary senator at the Technical University of Munich, received the economic medal of the state of Baden-Württemberg along with his wife Ayhan in 2019. In 2022, the couple was also recognized for their corporate culture and cooperation as Family Entrepreneur of the Year together with their children Ayla, Sami and Kaya Busch. This is the most important award for family businesses in Germany.

The employees of Busch Vacuum Solutions, Pfeiffer Vacuum and centrotherm clean solutions congratulate Dr Karl Busch on his 95th birthday and wish him many more healthy and active years.

Busch Vacuum Solutions
www.buschvacuum.com

Zumbach
 SWISS PRIME MEASURING SINCE 1957



RAYEX® S

Static X-Ray Measuring System

Benefits:

- ✓ All in one! Complete system for precision measurement of wallthickness, ovality, eccentricity and diameter.
- ✓ Fast measurement, immediate response to product changes.
- ✓ Operator friendly due to smart measurement algorithms.
- ✓ State of the art connectivity with integrated Profinet IO, Ethernet TCP/IP, Ethernet IP, or OPC UA communication protocols.
- ✓ Minimum maintenance requirement.

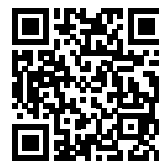

2

Min. object diameter (mm)



100

Max. object diameter (mm)



up to 20

Scan rate (scans/s)

Zumbach Electronic AG

Hauptstrasse 93 | 2552 Orpund | Schweiz
 Telefon: +41 (0)32 356 04 00 | sales@zumbach.ch
www.zumbach.com

Back to Normal Business Mode

■ Following the acquisition by Jwell in January 2024, Kautex Maschinenbau is back to its normal operative business and continues implementing the corporate strategy with a full focus on the final plastic product of its customers supported by its philosophy of process, quality and leadership excellence.

Haichao He, President of Jwell mentioned that the Kautex Brand, Machines, and Technologies have a strong image and are well known in the blow molding market. "With a well-developed strategy and well-skilled employees, Kautex continues building a brand reputation as a premium machinery solution provider in the blow molding machinery world. We continue to pursue this strategy consistently and enrich it with elements of the Jwell strategy."

After finalizing all requirements for the company registration, Kautex Maschinenbau is now back to normal operation mode. Three blow molding machines have been shipped out from the production facility in Bonn to customers so far after the successful factory acceptance test in Bonn. The next three machines will be ready in the upcoming months. Not only for machine delivery, the sales and after-sales activities have been a focus of the management team during these times.

The sales business is getting back on track again. The end-to-end supply chain management is working also very well.

The collaboration between the Kautex Team and Jwell Team was shown intensively in the last weeks with joint visits to customers in Europe and the Asian region.

Kautex Maschinenbau is entering a new chapter with a fresh leadership team. Thomas Hartkämper, CEO and CSO of the Kautex Maschinenbau Group will leave the company at his request. "After we were able to ensure that the established corporate strategy was maintained, I was able to accept a new challenge in my professional career with a clear conscience. The management team we have built up over the last few years represents the



Strategy launch at K 2022

path we have taken to align the Kautex Maschinenbau Group with sustainable growth. The entry of the strategic investor and the associated completion of the transformation is a very good time for me to hand over a reorganized and up-and-coming company to the next level," says Thomas Hartkämper.

After securing the brand, patents, and most relevant assets of the Kautex Group, Jwell has established a new company Foshan Kautex Machinery Manufacturing, Co. Ltd. In the region Shunde Foshan City, Guangdong Province.

Haichao He, the chairman of Jwell, takes over the role of the CEO, supported by. Quanquan Zhou. The finalization of the facility and the new company is still ongoing. Some operative topics can be handled already through the "NewCo" in Shunde.

Kautex Maschinenbau System GmbH

► www.kautex-group.com

Jwell Machinery Co. Ltd

► www.jwell.cn

Nomination for the German Innovation Award

■ As a country, Germany is understandably proud of its reputation for creating new and innovative products. And there is one award that recognises this more than any other: The German Innovation Award, operated and judged by the prestigious German Design Council.

In 2024, LEIBINGER is delighted to be nominated for the Award, thanks to its remarkable new IQJET industrial printer. But what is special about the newest and most advanced printer?

Continuous inkjet printing (CIJ) is an essential part of the production process for printing onto a huge variety of products, from food packing and furniture to eggs and electronics. The information they print – such as barcodes, batch numbers and expiry dates – is important for the efficient tracking of products and the digital operation of the world's supply chains.

But while modern businesses have had to reduce costs, improve sustainability, and reduce downtime, many manufacturers are still using legacy platforms selling of printer that has been in use for decades. Not so with LEIBINGER, the company has constantly innovated to address these major concerns in the following ways.

Maintenance free for 5 years: The IQJET is maintenance-free for five years thanks to its SMART. CARE concept. Unlike other CIJ printers, the IQJET has no constantly running feed pump, reducing wear and tear on components. Reducing maintenance costs to zero is a huge advantage for cost-conscious businesses.

No production stops for cleaning: When there is a break in production, many printers become clogged as ink dries on the printhead. This entails lengthy cleaning cycles prior to resuming production, where even an



CEO Christina Leibinger is delighted that IQJET has been nominated for the German Innovation Award. (Source: Paul Leibinger GmbH & Co. KG)

Paul Leibinger GmbH & Co. KG
www.leibinger-group.com

hour of downtime can result in significant costs. The unique IQPRINT technology used in IQJET eliminates this completely. IQPRINT combines the LEIBINGER automatic nozzle sealing technology with a new smart ink management system.

Lowest operating costs and environmental impact on the market: By automatically sealing the ink circuit, IQJET uses far less ink than competitors. It also condenses evaporated solvent and feeds it back into the system. Even the new cartridges are designed to empty to the very last drop, unlike many competitive designs. In terms of power, the IQJET also draws only 36W on average, making it one of the most efficient on the market. The result is a more sustainable solution that reduces consumption by 50%. LEIBINGER summarizes this overall package of IQJET benefits as SMART.EFFICIENCY.

The SMART.OS technology of IQJET offers straightforward installation and effortless operation. With its diverse range of interfaces, including OPC UA and an integrated PLC, IQJET seamlessly integrates into any packaging line. The latest HMI provides an intuitive user experience through drag & drop functionalities like on a smart device.

German companies are known for their innovation and quality. Since the LEIBINGER company was founded in 1948 by Paul Leibinger it has always innovated to meet the changing needs of customers. Now, in 2024 under the guidance of Paul Leibinger's grand-daughter Christina Leibinger, the company is delighted to continue that tradition.

SIKORA

Technology To Perfection



X-RAY 6000 PRO – 360° measurement of hoses & tubes

- Measuring ranges from Ø 0.65 to 270 mm
- Min. wall thickness > 0.3 mm
- Up to three different layers
- Automatic control of each layer to minimum wall thickness
- "One Button Operation" – no calibration, no parameters
- Measurement of corrugated pipes with „C-PIPE“ version
- Continuous quality monitoring and documentation



www.sikora.net/xray6000

Process Simulation Enhanced by Realistic Cost Calculation

■ Until now, simulation results were only measurable – soon, they are also countable. SIGMAecon enables process-dependent cost calculation, thereby providing the opportunity to determine the best compromise between quality, optimal process, and minimal costs. With the new version SIGMASOFT® 6.1, SIGMA Engineering releases SIGMAecon among other features. This tool offers the possibility of cost estimation directly combined with simulation results. Thus, the best compromise between quality, process, and costs can be quickly identified, as quality, productivity, and resources are simultaneously considered.

The detailed knowledge of own production processes and their optimization possibilities is crucial in the increasingly competitive environment. Often even more important is knowing the real manufacturing costs. For instance, is an (assumed) optimization associated with lower costs due to reduced cycle time? Or do costs increase due to higher energy consumption?

Securing a contract often depends on offering an aggressive selling price. However, turning such a project into a sustainable success requires precise knowledge of one's own costs beforehand. During the inquiry phase, SIGMASOFT® allows for quick examination and optimization of several important scenarios. Accurate predictions regarding time, material or pressure requirements, flow diagrams, etc., can then be provided to the pricing calculation as well-founded references.



However, SIGMAecon takes it a step further by allowing the user to precisely determine the component costs of the currently simulated process and its optimization variants. Modified thermal concepts are not only considered as additional costs or material savings but also in terms of the energy consumption.

SIGMAecon includes predefined templates as well as the ability to define all inputs freely. The results are presented in tables or diagrams but can also be evaluated directly from a Design of Experiments (DoE) with SIGMASOFT® for comparing different scenarios. This enables the optimization of manufacturing costs, which are now known in detail at the earliest possible stage.

SIGMA Engineering GmbH

→ sigmasoft.de

Market Study: Plastic Pipes

■ Things are looking up again for manufacturers and distributors of plastic pipes: the current year already promises a recovery. The latest edition of Ceresana forecasts an

CAGR of 3%. However, the outlook varies greatly from region to region. In Western Europe, demand is not expected to exceed the 2021 level until 2025. The construction industry in China is also finding it difficult to build on previous records. North America, on the other hand, is setting a faster pace. In the USD in particular, the government is currently investing large sums in the infrastructure of the future, for example USD 15 billion in replacements for old lead potable water pipes alone.

(in USD & EUR) as well as production and demand (in tonnes) are given.

Chapter 2 examines the largest national markets individually: Revenues, imports and exports in the 16 most important countries. The production and demand volumes are stated separately for the various types of plastic: PE, PP, PVC, and Other plastics.

In addition, demand and revenue are presented for each country, broken down by application: Sewage, Potable water, Cable protection, Gas supply, Agriculture, Industry, and Other applications.

Chapter 3 provides 97 company profiles of the most important producers.

Market Study: Plastic Pipes

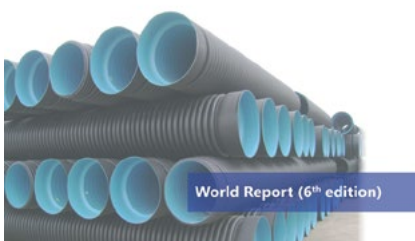

The study in brief:

Chapter 1 provides a presentation and analysis of the global market – including forecasts up to 2032: For each region of the world, revenues

→ <http://ceresana.com>

New COF Indicator Simplifies Measuring Friction on Packaging Film

■ Tentoma, the manufacturer of RoRo StretchPack® machines has introduced the COF indicator ST 1.0 tool to estimate if the coefficient of friction (COF) on the packaging film meets your requirements. It is a simple tool that can be used on-site by the service team or the operators on the packaging line. Doing a slide test with two film samples, the estimated COF value can be read from the integrated scale. If the value indicates an incorrect coefficient of friction, the film supplier must be contacted. Film suppliers typically have access to measuring instruments for measuring the precise COF value following the ISO standard. This will clarify if the packaging film has the required COF value.

The right COF value on the packaging film is crucial for optimal performance and reaching the maximum capacity of a packaging machine. However, the COF on a film roll can differ from the supplier's specifications. This discrepancy often goes unnoticed until the film roll is installed, leading to packaging machine failure. Therefore, when experiencing repeated packaging failures, it's always recommended to verify the COF of the packaging film. It is to help in such situations that Tentoma has introduced the tool COF indicator ST 1.0.



The new COF indicator ST 1.0 by Tentoma, simplifies measuring the friction on packaging film

The COF indicator ST 1.0 is a simple slide tester tool designed quickly to estimate COF on packaging film. The tool only estimates the COF value but is more affordable than a more precise COF measuring instrument following the ISO standard. Thus, the CF indicator allows manufacturers with a packaging line to measure the friction on the packaging film, to clarify if this is an issue.

Tentoma A/S

► <https://tentoma.com/cof-indicator>

TROESTER

130 YEARS TROESTER

EXCELLENCE IN EXTRUSION

DKT 2024
July 1 - 4, 2024
Nürnberg, GERMANY
Booth No. 9-611, Hall 9

PARTNER OF THE RUBBER INDUSTRY

As an innovative manufacturer of hose systems, TROESTER offers a high range of extruders with single or multi-layer heads for the manufacture of hoses with uniform wall thickness over the entire hose circumference. High-precision systems continuously measure the wall thickness which – with only a few control steps – ensure an eccentricity of less than 0.01 mm for the entire production period. Hose extrusion systems from TROESTER for the economic production of hydraulic and industrial hoses increase product quality and deal sparingly and carefully with environmental resources.

www.troester.de



Carbon Footprint for Products and Entire Companies

■ The SKZ Plastics Center has had a research group on the subject of sustainability for 19 years. As a result, scientists at the Würzburg Plastics Institute can draw on a wealth of experience and a comprehensive database on materials and plastics processing. The SKZ uses this knowledge to support companies from industry.

In the course of the sustainability reporting obligation, the determination of the CO₂ balance for companies is currently gaining even more importance. The carbon footprint determines the sum of all climate-relevant gases emitted by a product (product carbon footprint) over its entire life cycle or by a company (corporate carbon footprint). It is a starting point for developing an effective climate strategy. However, there is often a lack of basic data, which must first be laboriously determined.

SKZ researchers not only look back on many years of practical experience, but now also have a good basis of comparative and standard data. This means that the employees in the Sustainability department at SKZ can not only create CO₂ balances for individual products or entire companies in accordance with ISO 14067, but also provide support in identifying adjusting screws and selecting suitable measures to enable plastics producers and processors to act more sustainably.

"Our carbon footprints are calculated and comprehensively doc-



At the SKZ, a complete area is available for questions relating to plastics and sustainability (Photo: Luca Hoffmannbeck, SKZ)

umented according to recognized methods and standards and thus provide a sound database for climate-specific product and company assessment," says Dr. Hermann Achenbach, Head of Sustainability at SKZ. "We are currently facing a very high demand, as the plastics industry has recognized the signs of the times and is working intensively on climate protection and is also accelerating the transition to a circular economy. We want to act as a trailblazer for the industry here and are happy to support it to the best of our ability," says Achenbach.

In addition to the comprehensive support, it is now also possible to access free online tools developed at the Plastics Center – such as SCO2RE for CO₂ balancing of technical plastic recyclates. The SKZ also offers further training on this topic: a course entitled "Calculating your own CO₂ footprint" provides participants with the necessary tools to evaluate their own products in terms of climate protection.

The SKZ Plastics Center
Dr. Hermann Achenbach
h.achenbach@skz.de
➔ www.skz.de

Joint Project Proves the Feasibility of Separating Multilayer PVDC Films from Polyolefins in Used Packaging Structures

■ Syensqo and TOMRA, a leading provider of sensor-based sorting technology and solutions for the circular economy, have joined forces to demonstrate the technical and economic feasibility of separating and sorting multi-component plastic structures in which polyvinylidene chloride (PVDC) serves as a barrier layer.

The partners developed a joint set of experiments with multilayer sam-

ples of commercial packaging waste consisting of low-density polyethylene (LDPE) and Syensqo's Ixan® PVDC. The results have proven that multilayer films containing PVDC can be separated from mixed plastic waste using industrial sorting equipment to achieve clean-grade polyolefin and PVDC recycling streams.

"The overall target of this project was to challenge major industry

standards which claim that multilayer PVDC films cannot be sorted out of multilayer packaging structures," explains Federico Baruffi, Global Marketing Manager, Specialty Polymers, at Syensqo. "Our experiments have demonstrated the contrary and are sending a clear message to the packaging and recycling industry that it can be done, notably with good accuracy

and repeatability using existing industrial technology.”

The positive results apply to markets that are currently generating multi-layer mixed plastic waste containing PVDC, such as shrink films in consumer and food packaging.

“One of the concerns in the recycling industry was the reliable identification of polymeric waste with PVDC content,” adds Marco Gregori, Area Sales Manager Italy at TOMRA Recycling Sorting. “By combining our advanced optical and near-infrared detection systems, we managed to achieve a selectivity rate of more than 80% when sorting from post-consumer plastic mix and more than 95% when sorting from LDPE monolayer stream. This is yet another example of what today’s technology, in this case our AUTOSORT™, can already do.”



Syensqo partners with TOMRA to advance the sorting of multilayer PVDC packaging waste (Photo: Syensqo)

Altogether, these results have extended the scope of mixed plastic waste suitable for recycling to a wide range of multi-layer structures containing PVDC. The joint project between Syensqo and TOMRA is also considered a role model of advancing the circularity of the plastics industry through the dedicated

research and development of industry partners who share similar values.

Syensqo
www.syensqo.com

TOMRA Recycling Sorting
www.tomra.com

US Compostability Certificate for Limestone Based Bioplastic Received

■ GAIA Biomaterials limestone-based bioplastic material Biodolomer has just been certified for compostability by BPI in the USA. Since before Biodolomer had a similar European certification by TÜV Austria. „Now we can show brands and customers that Biodolomer is certified by the two most respected authorities in the world,” says CEO Peter Stenström.

Biodegradable Products Institute (BPI) has been the leading authority on compostable products and packaging in North America for over twenty years. BPI provides third-party verification of whether an item meets ASTM’s compostability standards. It is also a method for ensuring that all claims of compostability are supported by scientific evidence, as requested by the FTC.

The current BPI Certification mark covers Biodolomer for film applications. More certification processes are underway.

"We have been producing Biodolomer for nine years", says CEO Peter Stenström. "Unlike many other bioplastics, it does not use materials grown on farmland. It is based on limestone, one of the most common materials on the planet. Biodolomer does not result in any microplastics and reduces CO₂ emissions by up to 80% compared to fossil plastics if burned."

Biodolomer is used for a variety of film-based applications, such as grocery bags, aprons, and various farming uses. Biodolomer granules can also be used in thermoforming, blow molding, tube extrusion, extrusion coating and 3D printing. Making it possible to use it for a large number of single-use products, from drinking



straws to beer cups, bottles, and food containers. It can be used in the same production lines as traditional plastic with minimal adjustments.

It is becoming increasingly clear that recycling alone can’t solve the world’s plastic waste problem. Compostable materials are an important part of the solution – especially regarding food packaging – and they do not need new infrastructure.

"One main concern in recycling is packaging materials that end up in food waste and contaminate it so that it can’t be composted. With BPI-certified materials such as Biodolomer, this is not a concern," says Peter Stenström.

GAIA Biomaterials
www.gaiabiomaterials.com

Spiderless Pipe Die for Extrusion Introduced

■ Guill Tool recently announced the availability of its Spiderless Pipe Die. This new offering utilizes precision tooling to provide increased material savings compared to conventional basket dies for pipe extrusions.

In the coming years, the global market for pipes used in irrigation/sewage systems and industrial applications is expected to grow. This increased demand for pipes is driven by the increasing need for water and wastewater infrastructure, as well as the growth of industrialization and urbanization. These factors are expected to drive demand for pipes in emerging economies such as China, India and Brazil, as well as in developed markets including the U.S. and Europe.

Used by tube and pipe producers for larger diameter capabilities, this new pipe die is capable of providing a finished extrusion with OD from 2"-15". It's offered in 4140 steel or stainless with heat treating.

The company's Spiderless Pipe Die design differentiates itself from a basket die with its focus on precision tooling gained from decades of experience in medical tubing, flow analysis and Guill's ISO 9001 and AS9100 (Aerospace) quality systems. The significance of the Guill Spiderless Pipe Die becomes evident when considering material savings.

In general, the cost of the polymer material can range from 50% to 70% of the total cost of producing polymer



Guill Spiderless Pipe Die



pipes. The cost of other materials such as additives, fillers and reinforcements, as well as the cost of energy, labor, equipment and overhead also contribute to the total production cost.

In some cases, the cost of energy, particularly electricity and natural gas, can be a significant part of the total cost of production, especially for large-scale production facilities. In other cases, labor costs in regions with high labor costs, can significantly impact the cost of production.

Also a factor is that the cost of the raw polymer can be affected by market fluctuations in the price of oil, impacting the cost of petrochemicals used in the production of polymers. Additionally, the cost can also be influenced by supply and demand factors and global trade dynamics.

Guill's Spiderless Pipe Die is now available to meet the needs of its customers as they consider all the factors needed to remain competitive in pipe production. This product was entirely conceived, designed, engineered, manufactured and tested at the Guill factory in West Warwick, Rhode Island.

Guill Tool & Engineering, Co., Inc.
 → www.guill.com/series/900-series/

www.smart-extrusion.com

Record-Breaking NPE2024 – NPE2024 Captivates and Inspires Global Leaders and Rising Stars to Shape the Future of the Plastics Industry

NPE2024: The Plastics Show concluded a momentous week with an incredible turnout that has reinforced its position as the premier plastics industry event in the Americas. Over 50,000 registrants signed up for the show.

This year's show welcomed new faces, with 63% of attendees experiencing their very first NPE. NPE2024 has made history with one of the youngest audiences ever recorded. 30% of attendees were under the age of 40, marking the growing enthusiasm for innovation, sustainability and the promising future of the plastics industry.

NPE2024's global reach reestablished its reputation as the international gathering place of the plastics industry in the Americas. More than 15,000 international registrants marked the most international show in NPE's history. Representatives from 133 countries – or 68.2% of nations worldwide – registered to attend the global plastics trade show.



This is a 9.9% increase of countries registered at NPE2018, demonstrating the exchange of industry innovation and ideas on a global scale, and further shaping the path of international plastics collaboration and solutions. This strong international presence was further underscored by sold-out events like the FLiP & Sip Reception, drawing in more than 1,000 attendees and the Women in Plastics Breakfast, which attracted almost 600 attendees



"Witnessing the entire plastics industry reunite at NPE2024 was truly inspiring," said Matt Seaholm, PLASTICS' President and CEO. "We were thrilled to welcome familiar attendees, visitors from all over the globe and the next generation of plastics professionals. We cannot wait to see the incredible innovations and collaborations that will emerge from everyone who attended and are proud to say that we produced a historic, can't-miss event in the plastics industry."

To get a recap of NPE2024, visit npe.org/npetv for daily episodes of the innovations on the show floor. The NPE team looks forward to the next show happening May 3-7, 2027, in Orlando, FL.

► NPE.org

Recycling Innovation Lowers Melt Temperature and Saves Energy

Due to their properties, household waste, supermarket film, agricultural film and input materials from similar sources place high demands on the recycling process. The quality of the recycled pellets depends largely on the gentle treatment of the melt and the effective removal of impurities. To meet these kinds of challenges, EREMA has developed the new INTAREMA® TVEplus® DuaFil® Compact. The recycling machine manufacturer presented the system at NPE2024. Another highlight was: ReFresher technology for odor-optimized and food-safe recycled polyolefin pellets has now reached a total capacity of one million tons per year worldwide.

"The potential for plastics recycling on the American market is enormous," says Robert Wahlmüller,

CEO of EREMA North America in the run-up to NPE 2024. "Our order books are well filled and we have a promising outlook for the new financial year that has just started". At its trade show stand, the company is placing a special focus on the INTAREMA® series, underlining EREMA's broad offering for the post consumer sector. First launched at the K 2022 trade fair in Düsseldorf, the INTAREMA® TVEplus® DuaFil® Compact double filtration system is the industry benchmark for recycling challenging materials with high levels of contamination and moisture, such as film waste with paper labels from commercial waste, agricultural film and washed film from household waste.

A key feature of the machine is the consistently gentle treatment of

the melt throughout the entire process. This is the result of combining the TVEplus® system with the new DuaFil Compact technology. Thanks to the compact configuration of the machine, the extruder screw is 10 L/D (length-to-diameter ratio) shorter compared to the previous EREMA double filtration solution, and there is no longer a need for the discharge metering zone. The melt is processed more gently overall, also because a dedicated melt pump is used to increase the pressure upstream of the second filtration unit.

When recycling DSD 323-2 (flexible PE and PP household waste), for example, the new INTAREMA® 1108 TVEplus® DuaFil® Compact reaches a melt temperature upstream of the second filter unit that is around 22 degrees Celsius lower,



The new INTAREMA® TVEplus® DuaFil® Compact is significantly shorter than the previous EREMA double filtration solution. This pioneering recycling technology handles the melt gently and saves melt temperature and energy (Image: EREMA GmbH)

with around 11 percent lower specific energy consumption (kWh/kg) and around 14 percent higher throughput compared to the previous EREMA solution.

Since K 2022, EREMA has sold around 20 INTAREMA® TVEplus® DuaFil® Compact systems. The first machines have been delivered and have now entered operation. At RECUPAC S.A., for example, a recycling and waste disposal company based in Chile.

An application that is currently growing in the USA is the recycling of agricultural film. The producers receive film after it has been used, recycle it, and return it to production. The demand for technologies for processing heavily printed films is also increasing. Both applications are challenging: agricultural film is

typically heavily contaminated with sand, stones and organic matter, and printing inks often enter the material being recycled during the melting process. The INTAREMA® TVEplus® DuaFil® Compact provides the high degassing performance required to achieve excellent results using a very efficient process. When recycling agricultural film, for example, EREMA has been able to save 20 degrees Celsius in the melt temperature and 9 percent in energy consumption. At the same time, throughput increased by 11 percent.

EREMA launched the ReFresher for producing odor-optimized recycled pellets at K 2016. There are now ReRefreshers in operation worldwide for film and regrind applications with a total capacity of 1,000,000 tons per year. Combined with the

INTAREMA® TVEplus®, the anti-odor system opens up completely new application possibilities for recyclates, such as high-quality end products for the home, automotive and lifestyle sectors, and for processing food-safe polyolefin recycled pellets (HDPE, LDPE and PP). The process has been classified by an American food safety authority as suitable for feeding the recyclate back into the production of food packaging.

With its VACUREMA® and VACUNITE® systems, EREMA also offers the right solution for the production of food-safe rPET pellets. "Think big and safe - that's the message to our bottle-to-bottle recycling customers," says Christoph Wöss, Business Development Manager for bottle applications at the EREMA Group. In this connection, he points out that customers can now obtain complete systems including SSP post-treatment directly from EREMA, that can process up to 12,100 pounds (5,500 kilograms) of food-safe rPET pellets per hour.

EREMA Group

www.erema.com

Smart Solutions for Plastics Recycling and Compounding

At NPE 2024, Coperion and Herbold Meckesheim presented a variety of advanced components and solutions for plastics recycling and processing at their booth.

As a raw material, plastic can make a valuable contribution to environmental protection, the energy revolution and a circular economy. The key is efficient recycling of plastics. For this reason, plastics recycling is the focus of comprehensive development projects at Coperion and Herbold Meckesheim. The two companies showed the results of these projects at NPE 2024 by presenting combined process solutions and technologies for the economical recycling of various plastics while

achieving the highest levels of product quality. On display in the booth was a ZSK 58 Mc18 twin screw extruder configured for manufacturing high-quality PET using recycled materials as well as the recently introduced ZS-B 70 MEGAfeed side feeder for lightweight fiber and flakes recycling and a Herbold Meckesheim HV70 plastcompactor. Also on display was a new Schenck Process FPM MechaTron® Flat Bottom (FB) feeder, a high-capacity stainless steel feeder that is designed specifically for handling materials with light and fluffy characteristics such as films and scrap. More equipment for feeding, dust collection, pneumatic conveying, and bulk material handling

Thanks to its high intake potential, the recycling of plastic fiber and flake using the ZS-B MEGAfeed side feeder from Coperion becomes much more economical or even possible in the first place (Photo: Coperion, Stuttgart, Germany)

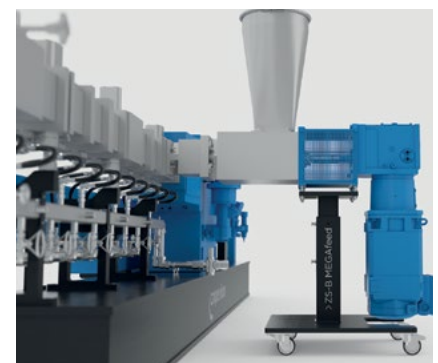

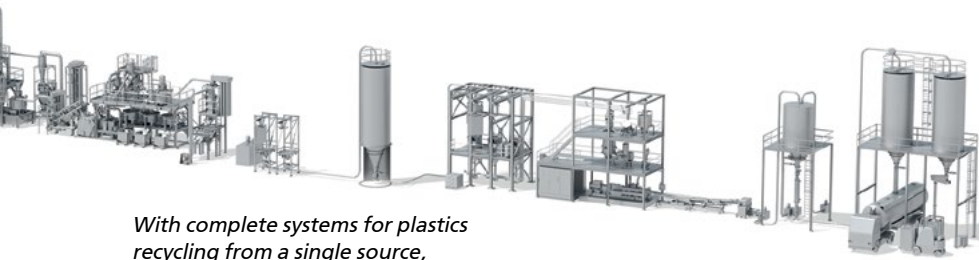

With complete systems for plastics recycling from a single source, Coperion and Herbold are setting new standards for the industry (Photo: Coperion, Stuttgart, Germany)

components were on display in the joint Coperion and Schenck Process FPM booth.

With the combination of Coperion and Herbold Meckesheim technology and know-how, the two companies are able to provide efficient plastics recycling solutions from mechanical processing – shredding, washing, separating, drying, and agglomerating of plastics – to bulk material handling, feeding and extrusion, as well as compounding, pelletizing and odor reduction, to complete systems. Customers have access to individual components as well as complete recycling systems from a single source, supplying highest end product quality and throughputs. Since their merger, both companies have continued to develop and optimally attune their technologies so that entire systems excel in operation with extremely high efficiency.

For feeding voluminous flakes and fibers (PET and other plastics) efficiently into a ZSK twin screw extruder, Coperion showed the innovative, recently developed Coperion ZS-B 70 MEGAfeed side feeder. Plastic recyclate with a bulk density starting as low as 20 kg/m³, long considered intake-limited and thus not worth recycling, can be reliably fed in large quantities into smaller sizes of Coperion's ZSK twin screw extruders and be concurrently recycled and compounded.

Conventional technologies for recycling PET require pre-drying and crystallization of flakes and fibers before they can be re-processed. Using Coperion's ZS-B 70 MEGAfeed side feeder, PET recyclate can be introduced directly into the ZSK extruder. Recyclers profit particularly from the very high end product quality. Thanks to the ZSK's very good devolatilization properties, volatile

components such as monomers, oligomers and water are reliably removed. Savings in operating and logistics costs as well as reduced energy consumption are further advantages of Coperion systems for recycling PET. The high quality of recycled PET manufactured using this innovative Coperion process was approved by the U.S. Food and Drug Administration (FDA) for direct contact with food (letter of non-objection).

The high-performance HV70 plastcompactor, also on display in the booth, is the most powerful of the series from Herbold Meckesheim. It processes the feedstock in continuous operation between a rotating and a fixed compactor disk, which are equipped with screwed-on and easily exchangeable kneading bars. HV plastcompactors can be used to agglomerate a wide variety of materials into products of high bulk density: thermoplastics such as fibers, fine particles, small tapes, foams, stretch or thin films, powders or shavings, as well as plastics that are difficult to convey, stock or mix. The HV 70 moreover combines high throughput and low wear costs with a fully automatic control system in which settings for different feedstocks can be recorded. Thanks to performance and temperature monitoring, the process is controlled in such a way that only a minimum of personnel is required.

Also on display was the Schenck Process FPM MechaTron® Flat Bottom (FB) feeder. This high-capacity stainless steel feeder is designed specifically for handling materials with light and fluffy characteristics. With a bottom driven vertical agitator and an auxiliary agitator, the MechaTron FB is perfect for hard to feed materials such as chopped polypropylene or PET plastic film when feeding to an extruder. Since 2023 Schenck Process FPM is part of Coperion; both brands presented their joint forces for the first time at this year's NPE.



The HV 70 plastcompactor is the most powerful of the series from Herbold Meckesheim. It processes the feedstock in continuous operation between a rotating and a fixed compactor disk, which are equipped with screwed-on and easily exchangeable kneading bars (Photo: Herbold Meckesheim, Meckesheim, Germany)

Coperion's twin screw extruder technology possess numerous advantages that are especially beneficial in chemical recycling of plastics. The technology is particularly well suited for an efficient energy addition and covers a broad range of throughputs. On larger ZSK extrusion machines, throughputs of up to 20 t/h ensure continuous feeding of the reactor.

Cameron Kheradi, Head of Process Technology at Coperion USA, said: "Plastics recycling is one of the core topics that we are emphatically promoting in order to better support the plastics industry on its path to a circular economy. We are very proud of our newly developed technologies and processes that achieve first-class product quality and make plastics recycling significantly more efficient. The innovative ZS-B MEGAfeed even makes it possible to recycle certain plastic fibers and flake in the first place. With our new Recycling Innovation Center, we have the optimal environment for developing further technologies and working together with our customers to optimize recycling processes."

Coperion GmbH
www.coperion.com

Herbold Meckesheim
www.herbold.com

New Rotary Die and Cam Lock Design Featured at NPE

Guill Tool unveiled new, simplified designs for its cam lock feature and rotary die at NPE 2024. The new rotary head offers a simplified design, while the cam lock will now be available on additional heads besides the Bullet.

The cam lock is the same as supplied on the Bullet and will be supplied on additional heads, where applicable. It allows quick and easy assembly and disassembly of the crosshead and eliminates the socket head caps screws. By removing and replacing the internals, a different profile can be extruded in minutes rather than hours. Since the cam lock resets the internals in the right configuration every time, there's far less chance of error, compared to the assembly and misalignment issues with socket set screws. The cam lock offers several features such as: it takes only ½ turn to remove and install the deflector tip and no fastening hardware is required. Additional features include fast tool changes (threaded retaining ring for the die and threaded tip retainer), dies remove from the front and tips from the back, tooling retainers for gum space adjustment, vacuum connections, simplified cleaning and reduced downtime and operating costs.

Guill's new rotary head is a simplified design compared to its previous models. By rotating the tooling in relation to the material flow, a rotary head increases the wall

strength of an extrusion, thereby allowing a thinner wall with less material. Features include only rotating the die, randomizing any gauge bands or thickness variations and in some cases, improving material properties of the end product. Various sizes of tubing can easily be accommodated with the unique Guill cam-lock design that radically reduces set-up and changeover times.

Extruders can realize a cost savings due to the elimination of secondary processes, cosmetic enhancement of the end product with the elimination of weld or parting lines, plus reduction or complete elimination of ovality.

Typical applications for rotary heads include medical and multi-lumen tubing plus various high-end extrusions with interlocking layers or multiple striping requirements.

Corrugated Tube Crossheads and Dies

Guill Tool offers their patent pending extrusion tooling, Series 400. It's adaptable to a wide variety of corrugated equipment and mold. The Series offers a host of benefits for OEMs, as well as for automotive and medical applications.

The unique tooling includes the multi-port spiral flow design that provides a balanced compound distribution with no weld lines to the corrugator. The elimination of weld lines significantly increases the finished product's overall strength.

Models offered include 420, 423, 432 and 434. Features of the 400 Series include Spiderless Inline, fixed center or adjustable, built in cartridge heaters, adjustable gum space, low inventory, expandable to multi-layer, heated core pin and one-piece body/flow diverter.



Rotary die

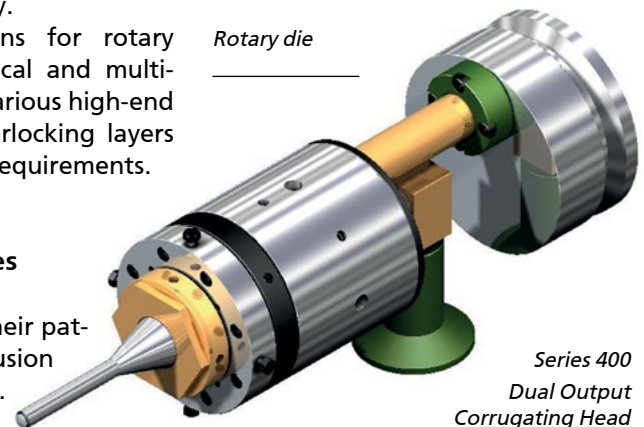

Series 400
Dual Output
Corrugating Head

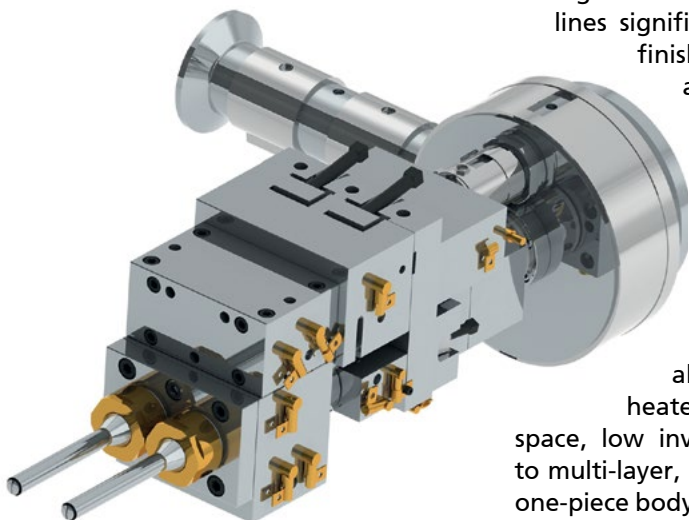

Since there are no spider lines, there's room for more air and no cold legs. Most products should be fixed. Users can change only one component and become fully adjustable. The cartridge heaters offer even heat for better flow and ensure there aren't any cold spots. More control of product size is achieved with adjustable gum space. Low inventory results in no burning or stagnation-quick color change. Due to the fact that it's expandable to multi-layer, the crossheads run a variety of products. Lastly, benefits of the heated core pin and one-piece body/flow diverter are better temperature control and easy cleaning-quick changer, respectively.

Advanced C:GRAN Series Introduced at NPE2024

At the forefront of plastic recycling innovation, Next Generation Recyclingmaschinen (NGR) announced the debut of its revolutionary C:GRAN series at the NPE in Orlando. This new series sets benchmarks in the recycling industry with its advanced cascade option featuring our high performance Power Venting Section and the newly developed AUTO-Pilot control system.

The new C:GRAN series is engineered to process a wide range of materials efficiently – from dry, clean post-industrial waste to wet, heavily contaminated post-consumer material. Available in eight machine sizes with throughputs ranging from 300 to 3000 kg/h, the series is designed to meet the diverse challenges of recycling.

"Our new C:GRAN series redefines the standards of plastic recycling, ensuring the effective transformation of various waste materials into high-quality granulate," stated Stefan Lehner, Product Manager of Post Consumer Recycling at NGR. The machines can process everything from BOPP and BOPET films generated as production waste to materials from washing plants and heavily printed films with stringent degassing requirements. This capability ensures the effective reintegration of diverse plastic waste streams back into the production cycle as premium quality granulate.

Lehner added, "The series features two independent extruder drives, allowing optimal speed

settings for both the melting and degassing extruders. This configuration optimizes degassing and melting performance while maintaining lower melt temperatures due to the short process unit. Moreover, a clean separation between the extruder and cascade, with melt filtration in between, ensures that no contamination bypasses the melt filter, leading to a very stable process and preventing the production of off-spec granulate. 'Recycling & compounding' is also possible in a single step when combined with twin screw technology as part of the system."

The C:GRAN's modular design offers unparalleled flexibility, accommodating custom solutions while adhering to standards for specific recycling needs. It includes options such as retrofitting additional degassing zones or integrating a cascade with a second filtration stage – adjustments that can be made swiftly to optimize operational efficiency. The enlarged cutter-compactors of the C:GRAN series ensure high throughput values and high process stability despite varying input qualities. For high input moisture levels, the cutter-compactor can also be equipped with a special DRY-Boost to enhance material drying performance.

A standout feature of the C:GRAN series is the cascade configuration equipped with the new Power Venting Section, designed for the most difficult degassing challenges. This setup is crucial for processing materials with high lev-

els of contamination and moisture, effectively stripping deep volatile contaminants from the polymer melt. "The cascade's Power Venting Section, with three degassing openings and an innovative polymer flow path provides the ability to remove even the most challenging volatile contaminants, thus ensuring exceptional pellet quality. The location of the vent, after filtration, ensures optimized throughput and therefore energy efficiency," explained Greg Wool, Sales Director from NGR Inc..

The newly developed AUTO-Pilot control system in the C:GRAN series automates the entire recycling process, adapting seamlessly to changes in material characteristics such as density and moisture. This intelligent system adjusts the intake slider, cutter-compactor, extruder, and pelletizing speeds automatically, maintaining optimal processing conditions and consistent pellet quality without operator intervention. "The AUTO-Pilot feature virtually eliminates operator error, reduces the likelihood of unscheduled downtime and especially prevents melt-downs. It ensures that our machines operate at peak efficiency, with minimized energy use and enhanced safety" highlighted Stefan Lehner, the Product Manager for Post Consumer Recycling at NGR.

Next Generation
Recyclingmaschinen GmbH
www.ngr-world.com

*C:GRAN – CUTTER-COMPACTOR-
EXTRUDER COMBINATION
C:GRAN-CAS 125-150 with single-screw
cascade and Power Venting Section*



Cutting-Edge Factory Automation Solutions Launched at NPE 2024

■ Muller Technology, a leader in factory automation solutions for the plastics industry, expanded its product offering with the launch of custom mobile robotic systems at the NPE 2024 exhibition in May. The new factory automation solutions bridge the labor shortage gap in the U.S. plastics processing industry while also delivering greater versatility, flexibility, efficiency, and productivity.

Muller has expanded beyond traditional downstream automation, offering new Autonomous Mobile Robots (AMRs) and Mobile Manipulators (MoMas) which significantly improve productivity, reduce OSHA recordable events, and can run seven days a week/24 hours a day for a great return on investment.

"As the manufacturing landscape continues to evolve, Muller Technology remains at the forefront of innovation, providing cutting-edge solutions to address the industry's most pressing challenges," said Carsten Eisenkrämer Group CEO at Muller Technology. "With our latest product line and service offerings, we are empowering plastics manufacturers to unlock new levels of efficiency, productivity, and profitability."

Muller introduced its Mobile Manipulator (MoMa) which boasts innovative designs and unparalleled versatility. These cutting-edge manipulators are an AMR combined with a collaborative robot (Cobot) including a vision-based end-of-arm tool. They are capable of operating in microprocessor clean rooms, offering customers unmatched efficiency, productivity, accuracy, and cost reductions. The MoMa is a versatile solution that automates not only transportation of goods but also complex op-



erations such as picking items from shelves, assembling components, or placing delicate objects. It combines the best of both worlds – the flexibility of mobile robots (AMRs) and the precision of Cobots. They are integrated into the automation process as an AMR with a purpose-built top to transport empty or full boxes or pallets around your shop to improve your operational throughput, or to perform repetitive assembly processes and then moving the goods towards the warehouse or truck.

The company has launched AMRs into their portfolio of products as a Certified System Integrator for Omron products which play a crucial role in improving manufacturing and logistics processes while significantly increasing the flexibility of production areas. AMRs minimize health and safety risks in warehouses and factories, serving as a valuable complement to drive

efficiency and cost reductions in modern manufacturing and logistics processes.

Muller integrates AMRs and MoMas for a complete portfolio of technologies for turnkey automation operations for its customers. The company has partnered with Omron, one of the world's leading AMR manufacturers. Muller is an Omron Certified Systems Integrator for both of its operations in Fort Collins and Conthey, Switzerland.

Muller Technology Group prides itself on offering comprehensive services, including engineering, sales, aftermarket parts, and assembly operations, across both its facilities in Switzerland and North America. Muller provides a productivity edge by working close to customer operations in America and in Europe.

Muller Technology
www.muller-technology.com

Packs Over 21,000 Meals Packed for Charity at NPE2024

■ The Plastics Industry Association announced over 21,000 meals were packed at the first ever community service event at NPE2024, exceeding the association’s goal of 20,000 meals. The event, in partnership with Alliance Specialties and Laser Sales and U.S. Hunger, saw over 70 volunteers, including NPE attendees and exhibitors, come together to make a difference in the fight against hunger. All meals were donated to Orlando’s Second Harvest Food Bank for distribution to the local community.

“I’m thrilled we were able to surpass our goal for this event,” said Whitney Taveras PLASTICS’ Director of Industry Engagement (Equipment). “We are grateful for the amazing team of volunteers who packed over 21,000 meals for those in need. The plastics industry is dedicated to supporting local communities and this initiative was a true testament to that mission.”

“We were able to accomplish an amazing act of service at NPE2024,” said Tony Demakis, President of Alliance Specialties and Laser Sales.

“The event brought people together from across the plastics industry to serve others and make a difference for people in need in the local Orlando area. I’m so proud we exceeded our goal for this event and am thankful to PLASTICS and to all the volunteers.”

U.S. Hunger is a 501(c)(3) that has activated more than 950,000 volunteers to distribute over 160 million meals across the globe.

<https://ushunger.org/>

Building Business in a Competitive Market

■ It was not only the effect it had on public health, the Covid pandemic had a substantial impact on world trade, and its fair to say that the business scene today is fundamentally different from how it looked in 2019. The shortage of raw materials, the restrictions on travel and transport, the rapid change in consumer shopping habits, to name a few, all had a major impact on how investment in the capital goods sector was perceived and played out for the manufacturers involved – and Vetaphone was forced to review and revise the way it did business.

But, as with most crises, a new creativity emerged. Born of necessity, but based on good business practice, the company sharpened their focus on more efficient production methods of their leading-edge technology, and importantly, ramping up the customer support with additional technical staff and an enlarged parts store.

Many of the customers operate 24/7, working with very fine margins that can be seriously affected by downtime. In this production environment, reliability is essential. The problem is that all production lines are made up of many working parts from different manufacturers, and a chain is only as strong as its weakest link. All machines can break down. But it’s how a supplier responds to



a breakdown that makes the difference between success and failure.

This is especially the case in markets like America, where customers are spread far and wide. Vetaphone knows that it’s necessary to offer the security of local support, which the company cannot do from Europe. That’s why Vetaphone has invested heavily in a full after sales back-up of parts and service technicians who are locally based in the US. The company’s main parts store, located in Richardson, TX offers all Vetaphone’s American customers quick access to parts for next day delivery.

The parts store is close to the major DFW airport hub and stocks 90% of all routine parts for Vetaphone corona systems. With no significant time zone difference or language issues to contend with that might delay order processing, the American

Vetaphone has invested heavily in supporting its global customers

customers are now assured of the best quality back-up available in the market – as well as the most reliable technology, of course.

Best of all are the testimonials from satisfied customers, who keep coming back for more. Robert Parker of Label King in San Diego for instance who said: “In my view, Vetaphone is the Cadillac of this market!” or Tim Takken of A-PAC Grand Rapids who stated: “We installed our first Vetaphone corona treater in 2018 and the second in 2020. Although it was an unknown brand to us, we have been well pleased with the result and their local support.”

Vetaphone A/S
www.vetaphone.com

Continuous Commitment to Sustainability

■ Davis-Standard announced a significant milestone in its sustainability journey. All of its North American facilities are now powered by 100% carbon-free electricity. This achievement solidifies Davis-Standard's commitment to environmental stewardship and underscores its leadership in sustainable manufacturing practices within the industry.

By transitioning to 100% carbon-free electricity in North America, Davis-Standard has taken a decisive step towards reducing its carbon footprint and mitigating climate change impacts. This milestone aligns with the company's overarching sustainability goals and demonstrates its dedication to operating in an environmentally responsible manner.

Davis-Standard achieved this milestone by purchasing Green-e certified Renewable Energy Cer-

tificates (RECs) for its Pawcatuck, CT, and Fulton, NY, facilities. These RECs guarantee that the electricity used in these locations is generated from renewable sources, such as wind or solar power, further solidifying Davis-Standard's commitment to sustainable energy practices.

Additionally, Davis-Standard's Greater Toronto Area operations utilize electricity sourced from hydroelectric sources, further contributing to the company's carbon-free energy usage.

This accomplishment complements Davis-Standard's existing ISO 14001-certified facilities and its Mallefer brand's EcoVadis Silver Award, highlighting the company's dedication to sustainability and environmental responsibility across its operations.

"We are incredibly proud to announce that all of our North American facilities are now powered by

100% carbon-free electricity," said Giovanni Spitale, CEO at Davis-Standard. "This milestone reflects our unwavering commitment to sustainability and underscores our dedication to reducing our environmental impact. By transitioning to renewable energy sources and leveraging green certifications like Green-e and ISO 14001, we are taking proactive steps towards building a more sustainable future for generations to come."

As an industry pioneer, Davis-Standard remains steadfast in its pursuit of sustainability, innovation, and excellence. The company will continue to explore new ways to minimize its environmental footprint while delivering best-in-class solutions to its customers worldwide.

Davis-Standard, LLC

► <https://davis-standard.com/sustainability/>

Global Footprint Grows

■ Extreme Coatings, a leading global supplier of wear-resistant coating solutions for the plastics and rubber industries, has expanded its global footprint and invested in key personnel appointments to meet the growing demands of its business in North America, Europe, and Asia. At the NPE2024 exhibition, the company marked the 26th anniversary of its U.S. operation and announced the appointment of a new Director of Sales in North America.

The anniversary also coincides with expansions over the last 15 years in India and the last few years in Korea and Austria, where these centers all manufacture and sell wear-resistant coatings in respective and surrounding markets. The U.S. operation has grown steadily over the years as demand has increased in injection molding and extrusion feedscrews (single and twin-screw), and continuous mixing rotors. The international operations have been added to meet the global demands of plastics processors for

the automotive, packaging, and profile markets.

Extreme Coatings has also announced the appointment of industry veteran Steve Jackson as Director of Sales-North America for the Plastics and Rubber Division. Jackson brings 40 years of experience in plastics processing, serving in senior management, operations, engineering, purchasing, logistics, and design roles. He brings extensive knowledge in extrusion, injection molding, rubber, and hot melt processing.

"We're thrilled that Steve has joined the team and we expect valuable contributions as the company enters a high-growth phase," said Scott Caplan, Executive Vice President for Extreme Coatings. "His vast technical and business knowledge will help us further boost our industry presence and penetrate new applications."

Extreme Coatings' global footprint includes its newest manufacturing facility in Austria which is fully operational for the production

of high-performance coatings for feedscrews in injection molding and extrusion applications.

The company has established a European subsidiary, Extreme Coatings GmbH, and formed a strategic partnership with a leading Austrian engineering services company to operate the facility. The new 15,000-sq-ft plant is already meeting the application needs of a range of European customers including plastic part manufacturers for the automotive, packaging, and profile markets.

The increased capacity in Europe will shorten lead times, reduce shipping costs, and establish local supply for Extreme Coatings' growing customer base throughout Europe, according to Caplan.

"We've expanded our global footprint so we can break the logistical logjam that exists today and ensure stable supply to all key European regions," said Caplan.

Extreme Coatings

► www.extremecoatings.net

Investment in Startup

■ Chemovator, the business incubator and early-stage investor of BASF, has successfully finalized an investment in Heartland. The Detroit-based startup is a frontrunner in the production of natural fiber plastic additives, and the latest addition to Chemovator's external-facing Elevate program.

Supported by a team of scientists, engineers, and technologists, Heartland has developed hemp-based materials that can be used as additives within plastic compounds. This breakthrough advancement in the world of sustainable material innovation improves properties with regard to flammability, bonding, dispersion, and bulk density, which are historically associated with processing natural fibers. As a result, natural fibers are now a viable market opportunity to reduce scope 3 carbon emissions in numerous industries.

"By working with global brands and their suppliers, Heartland is able to reduce the carbon footprint of plastics on an industrial scale," comments Jesse Henry, CEO of Heartland.

With this funding, Heartland becomes Chemovator's first portfolio company in North America and the

latest addition to the Chemovator Elevate program. The program aims to support early-stage startups in the chemical industry through monetary investment, access to BASF and its experts, as well as support from a network of experienced entrepreneurs.

"Heartland's dedication to developing natural fiber additives aligns perfectly with our purpose of shaping the future of the chemical industry. This investment not only expands our portfolio to a new geography, but also underscores our commitment to innovation and sustainability. We look forward to supporting the Heartland team on its journey," adds Gati Kalim, Head of Portfolio Management at Chemovator.

The Investment builds on an existing partnership between Heartland and BASF's North America Open Research Alliance (NORA).

"We are not only continuing our collaboration with Heartland; we are strengthening this collaboration. Supported by the tireless efforts of our colleagues in the Performance Materials division, we work together to deliver sustainable solutions for our customers," says Thomas Holcombe, Head of NORA at BASF Cor-



As an additive for industrial materials such as plastic, rubber, and concrete, Heartland's Imperium Masterbatch, a product designed to be blended with polymers, enables the production of high-performance natural fiber products and packaging

poration. "BASF's partnership with Heartland will enable us to advance on our commitment to reduce scope 3 emissions* and create chemistry for a sustainable future."

The monetary and strategic support provided by Chemovator enables Heartland

to deepen valuable collaborations within BASF.

Heartland Industries Inc.

► www.heartland.io

Chemovator GmbH

► www.chemovator.com

Waste360 Features Op-ed



■ Waste360 has featured an op-ed written by Plastics Industry Association (PLASTICS) President and CEO, Matt Seaholm, published during the UN Global Plastic Pollution Treaty meetings at INC-4 in Ottawa, Canada. The piece highlights the industry's commitment to end plastic waste and work towards a collaborative solution to keep plastic in the circular economy.

"This week at the Global Plastics Pollution Treaty Meetings in Ottawa, Canada, participants will have an opportunity to come together and move the needle towards solutions

to address plastic pollution. With only two meetings left, these negotiations are at a critical point, which is why our industry has continued to come to the table supporting the effort to achieve a collaborative, robust international agreement that will put us on the path to ending plastic pollution worldwide. The way we see it, this meeting is where actual progress can be made. These negotiations will be a missed opportunity if we spend the week talking about how to stop the production of plastic, which, unfortunately, has been a focal point at past meetings."



Matt Seaholm

To read the full op-ed.

► <https://www.waste360.com/plastics/commentary-committed-to-end-plastic-waste>

2023 Global Impact Report Released

■ Ahead of the UN Global Plastic Pollution Treaty meetings taking place at INC-4 in Ottawa, Canada, the Plastics Industry Association (PLASTICS) and the American Chemistry Council (ACC) are releasing the 2023 Operation Clean Sweep® (OCS) Global Impact Report. OCS, an industry-led program that supports companies towards their goal of zero plastic resin loss in operations, is co-led by both organizations.

The report highlights how OCS is advancing resin loss prevention strategies across more than 60 countries, ranging from growth in industry participation to increases in rigor and transparency through data reporting and external inspections. The report also spotlights the more than 20 plastic and chemical associations OCS partners with to operate its programs internationally.

“As the Operation Clean Sweep continues to grow with more than 5,000 global members, the plastics industry remains dedicated to keeping pre-production plastic out of our environment,” said PLASTICS President and CEO Matt Seaholm. “The release of this report underscores our commitment to that goal while increasing transparency and ensuring accountability as we work to keep more plastic in the circular economy.”

“Plastic resin is the building block for everyday products,” said Ross Eisenberg, President of America’s Plastic Makers®, a division of ACC. “We are working hard so resins continue delivering the benefits that make modern life possible while embracing practices to help keep them out of our environment.”

Highlights from the 2023 OCS Global Impact Report include:

- The global OCS member count reached more than 5,000 with more than 300 new companies joining OCS.
- Three OCS programs launched external inspection programs: OCS Europe, OCS Turkey, and OCS Blue in the U.S., representing more than 50 countries.
- More than 50 countries across Europe implemented data reporting.
- Plastic manufacturers who reported in 2022 represent more than 50% of the U.S. production capacity for plastic resin in that year.

To read the full report:

► <https://opcleansweep.org/about/ocs-annual-report/>

Statement on ABC News’ Operation Clean Sweep Claims

■ The Plastics Industry Association (PLASTICS) issued the following statement in response to ABC News’ piece published April 26, 2024. The following statement can be attributed to Patrick Krieger, Vice President of Sustainability for the Plastics Industry Association:

“This ABC News report falsely implies that the plastic industry is not supportive of an international agreement to end plastic waste in the environment – nothing could be further from the truth. Our industry has been engaged in the UN negotiations throughout the entire process of the INC with a goal of achieving a collaborative, robust international agreement that will put us on the path to ending plastic pollution worldwide. Our industry created Operation Clean Sweep (OCS) to support the prevention of plastic loss from facilities and the supply chain. The OCS Malaysia program was recently launched in 2023 and we continue to work to grow the program’s adoption and impact. After being informed of this circum-

stance, we reached out to our local program partners and this facility to provide technical assistance and interventions to improve their operations. In the United States, our OCS third-party verification program includes visual inspection of outfalls and fence line, and our goal is to broaden adoption of that program internationally. The plastic industry remains committed to our sustainability goals and we want to collaborate to find workable solutions to achieve them. Operation Clean Sweep exists to help companies improve their own practices to achieve these goals and our industry is eager to broaden this program to ensure these are carried out globally.”

Operation Clean Sweep was founded by the Plastics Industry Association in 1991 and is managed in partnership with the American Chemistry Council’s Plastics Division. The industry-led program is dedicated to helping companies move toward zero plastic resin loss and is active in more than 60 countries worldwide. OCS members in the



Patrick Krieger

U.S. represent the full plastics value chain, ranging from companies making and distributing plastic, to transportation companies moving plastic, and processors manufacturing final products.

The Plastics Industry Association (PLASTICS)

► www.plasticsindustry.org

Exclusive Distributorship Announced

■ Elio Cavagna S.R.L., Helios Slitting, Galgagnano LO, Italy and Processing Technologies International, LLC, Aurora, IL have announced an exclusive distributorship agreement to supply slitters, parts, service and support to the United States and Canada.

The agreement focuses on providing sales, support and services for slitter and related components for plastic sheet applications, but it is likely to grow into additional support for the paper industry. This unique synergy and local hub for vital processing components provides a mutually beneficial value-added provision in terms of timely product availability that would otherwise take several weeks to months to fulfill through overseas negotiations. Furthermore, PTi Aftermarket, Customer Service and Process Technicians have been thoroughly trained on the product features, uses, and installation methods, which in turn can be relayed to onsite personnel via training or phone support.

Helios slitters integrated into a PTi Accumulator, located within the Technology Development Center (TDC) of PTi's facility in Aurora IL



Attilio Cavagna, president of Helios Slitting and Gary Kemp, Aftermarket Sales and Services Director of PTi, are excited to be working together exclusively to provide the necessary distribution and support for Helios slitters for sheet extrusion

Headquartered and founded in Italy in 1976, Helios has been operating in the cutting sector, specializing in shear, razor and pressure cutting systems and offering smart solutions for edge trim, central and multiple cut modules, fast man, and

knife position displays and operator interfaces. The areas of application are wide-ranging, mainly in flexible coil or sheet material.

According to Helios president, Attilio Cavagna, the agreement not only signifies a local presence in the United States and Canada, but will result in improved ease of sales, distribution and product expertise and customer satisfaction. According to PTi president, Dana Hanson, having the ability to quickly provide slitters, parts, service, support and training on components that are integrated into plastic sheet extrusion lines will allow us to better serve our mutual customer base and further enhance our Aftermarket product mix. Commercial terms and conditions of the agreement were not released.



Processing Technologies International, LLC (PTi)
www.ptiextruders.com

2024 Bioplastics Market Watch Report Released at NPE2024

■ The Plastics Industry Association (PLASTICS) released its 2024 Bioplastics Market Watch Report during an education session at NPE2024: The Plastics Show. “Bioplastics manufacturing is growing and consumers’ familiarity with bioplastics has increased, based on PLASTICS’ consumer survey,” said PLASTICS’ Chief Economist Dr. Perc Pineda. “Overall, the outlook for this industry is positive.”

Among the highlights found in the 2024 Bioplastics Market Watch Report:

- Bioplastics manufacturing revenue is now projected to grow at a Compound Annual Growth Rate (CAGR) of 1.9% to reach \$1.2 billion by 2028. The size of the U.S. bioplastics market will continue to vary depending on the different metrics used to quantify it. Never-

theless, the production capacity of bioplastics in North America, predominantly concentrated in the U.S., is estimated to account for 18.7% of the global production capacity.

- Although consumer perceptions of bioplastics continue to evolve, familiarity with bioplastics has increased significantly over a five-year period. In last year’s survey, 68% of consumers expressed a net familiar response, with just 14% indicating unfamiliarity. This marks a notable shift from the 2018 survey, where the net familiarity was 63%, with 31% indicating unfamiliarity.

- Competition within bioplastics manufacturing is expected to increase within and outside U.S. borders, driven by new materials development and new applications.



Dr. Perc Pineda

The full PLASTICS’ 2024 Bioplastics Market Watch Report can be downloaded:

➔ https://www.plasticsindustry.org/data-report/plastics-market-watch-watching-bioplastics-2024/?utm_campaign=The%20Perc%20Report&utm_medium=email&hsenc=p2ANqtz-LHxUwOoK0sLIF-hh7TMtawvlc-FWpGOkb2Frb-KzEc-5Wa82_u0EI0AOwMAq3a61x37G6F-byUD3qrnUqEb3iB2P26VFqelgq9cakxTY-38boPhVjuGs&_hsmi=305989369&utm_content=305989369&utm_source=hs_email

Analysis „End Pollution, Not Production“ Released

As the UN Global Plastic Pollution Treaty meetings take place at INC-4 in Ottawa, Canada, the Plastics Industry Association (PLASTICS) has released an official analysis of the U.S. trade surplus and its impact on any proposed plastics treaty, authored by PLASTICS Chief Economist, Dr. Perc Pineda. Dr. Pineda writes: “A reduction in plastic production could have unintended consequences, potentially putting healthcare workers at risk and de-

priving low-income consumers in developing countries of access to retail products packaged in plastics. Having experienced life in a developing country firsthand, I understand why low-income consumers often rely on single-use-sized products. For many, a significant portion of their income is allocated to food consumption and shelter—a reality that may not be fully grasped by individuals living in more advanced circumstances in G7 countries who

advocate for reducing plastic production. Obviously, the problem here is not plastics packaging production.

To read the full analysis on the PLASTICS blog page.

➔ https://www.plasticsindustry.org/blog/u-s-plastics-industry-posted-1-1b-trade-surplus-in-2023/?utm_source=bw&utm_medium=social-x&utm_campaign=null&utm_content=econ&utm_term=blog

Platinum Sustainability Rating by EcoVadis Earned

■ Orion, a global specialty chemicals company, announced its 2024 sustainability rating from EcoVadis has been raised from Gold to Platinum, the highest possible distinction.

Orion now ranks among the top 1% of the companies assessed by EcoVadis, one of the world’s largest providers of business sustainability

ratings. The organization revised Orion’s score from 78 to 82% after reassessing the company’s 2023 performance.

“Achieving the Platinum rating is a huge milestone for Orion considering that just three years ago we were at the Silver level. I want to congratulate our global team for their commitment and dedica-

tion,” Orion CEO Corning Painter said. “The assessment methodology is complex and involves numerous factors. We appreciate the rigor and dedication to accuracy that EcoVadis brings to the assessment process.”

Orion S.A.

➔ orioncarbons.com

New CEO in North America

■ Diego Areces has been the new CEO of Baumüller-Nuermont Corp (BNC), the North American subsidiary of the Baumüller Group with headquarters in Norcross near Atlanta (USA) and other locations in Chicago (USA), Toronto (Canada) and Querétaro (Mexico), since 1 April 2024. Areces has many years of experience in drive and automation technology and has been with the company since May 2023. He succeeds long-serving CEO Brad Fowler, who has retired after a total of 23 years at BNC.

BNC was founded in 1987 and has a strong customer base in the USA, Canada and Mexico. The company focuses on intelligent system solutions for electrical drive and automation technology for machine manufacturers in the converting, printing, packaging, energy, plas-

tics, metal processing and recycling sectors, among others. BNC also offers a comprehensive range of after-sales services and industrial relocations and installations. As a partner to the mechanical engineering and energy industries, BNC supports companies in the transformation towards sustainable energy generation and intelligent energy utilisation of the future.

The successful development of the company in recent years has been strongly characterised by Brad Fowler. The subsidiaries in Mexico and Canada were founded under his leadership. "Our thanks go to Mr Fowler, who played a key role in shaping the positive development of the company on the American market during his many years at Baumüller. At the same time, the service portfolio was further de-



veloped in a targeted manner, especially in the areas of service and industrial relocation and assembly. We wish Brad Fowler all the best in his well-deserved retirement and Mr Diego Areces and his team every success for the future," says Andreas Baumüller, Managing Partner of the Baumüller Group.

Baumüller-Nuermont Corp. (BNC)
www.baumueller.com

New President Global Services

■ Davis-Standard announced the appointment of Ching Gettman as President of the Davis-Standard Global Services (DS Global Services) team.

With a proven track record of leadership and innovation, Ching is set to drive the growth and excellence of DS Global Services, bringing increased value to the customer base through focused service and support strategy execution.

With over 20+ years of industry experience, Ching joins Davis-Standard from Caterpillar, where she served as Vice President of Product Development, Aftermarket, and Strategy. There, she led significant advancements in product development and aftermarket services, reinforcing Caterpillar's position as an industry leader. Prior to that, she spent 12 years at John Deere, holding various key roles across multiple locations, which provided her with extensive experience and a deep understanding of the aftermarket industry. She also worked as a distributor executive at Cum-

mins Western Canada, where she was responsible for Sales, Service, Rebuild, and Parts.

"Ching's experience and innovative approach make her the perfect fit for leading our DS Global Services team," said Giovanni Spitale, CEO of Davis-Standard. "Ching's leadership will enhance our service capabilities and strengthen our commitment to delivering exceptional value to our customers worldwide. Under her leadership, DS Global Services will focus on providing comprehensive solutions that improve our customers' performance at every step of the way."

"I am excited to lead DS Global Services in our mission to forge enduring partnerships with our customers by delivering a premium customer experience; we aim to be the most trusted and sought-after service and support provider in the industry. Our focus on quality, uptime, speed, cost savings, and flexibility reflects our dedication to enhancing our customers' performance and driving their success. DS



Ching Gettman

Global Services will elevate the standards of service excellence and support that our customers deserve."

Davis-Standard, LLC
<https://davis-standard.com/>

Unique Large-Diameter Pipe Line Expertise – *Two Record Lines Sold*

Giant pipes with a diameter of 2,7 m can be produced with the extrusion lines recently sold to north-east Africa. With its foray into the new dimension of 2,7 m large PE pipes, the extrusion line manufacturer battenfeld-cincinnati has set a new record. These are the first complete lines capable of producing pipes of this size and quality. The design incorporates both the company's unique overall system expertise, which intelligently combines the individual components from the material dosing system to the cutting unit without interface problems, and its decades of experience in the construction of large-diameter pipe systems. Continuous optimization to reduce sagging and thus increase pipe quality speaks for itself, as do mechanical engineering aspects that simplify the transport and assembly of the large components.

With the new lines, the two customers will expand their product range to include large pipes with an enormous diameter of 2,7 m and thus meet the increasing demand for high-performance fresh water and wastewater systems. Plastic pipes play a major role here, as they are easier to install due to their lower weight compared to concrete pipes, are resistant to corrosion and chemicals and cannot be damaged by tree roots in the ground. In other words, they are functional and durable.

In order to be able to produce pipes in these dimensions, high-performance extruders that can homogeneously plasticize the melt material are required. For some years now, battenfeld-cincinnati has been relying on the soLEX NG series, which achieves up to 25 % higher output compared to previous versions. Thanks to the process engineering design with an internally grooved barrel and matching screw and grooved bushing geometry, the extruders operate with a reduced axial pressure profile, which ensures low wear. At the same time, high specific output rates at low screw speeds and temperatures reduced by around 10 °C guarantee effective but gentle melt processing. The OptiMelt static mixer, which is installed between the extruder and the die,

achieves a further 10 °C reduction in temperature. The tool itself is a helix pipe head, which, with its two-stage concept, ensures optimum melt distribution with low pressure build-up. Finally, the effective internal pipe cooling supports the stable outlet of the melt from the die. The entire unit thus ensures minimized sagging effects, which is particularly important for large pipes and their high weight in order to guarantee optimum wall thickness distribution without ovality.

The downstream components are also designed for the large dimensions and also meet the requirements for low energy consumption. The vacuum and spray baths work solely with frequency-controlled vacuum pumps, which consume around 50 % less energy than conventional systems. At the same time, a closed water circuit in the complete calibration system ensures minimized water consumption of just 1 m³/h.

A brand new feature is that all downstream components are now only 4 m long, meaning that they can be easily transported to their destination and only need to be joined together.

battenfeld-cincinnati
 Bad Oeynhausen und Kempen (Deutschland),
 Wien (Österreich),
 Shunde (China), McPherson, KS (USA)
 → www.battenfeld-cincinnati.com

*Po Pipe Extrusion 106
 inches line*

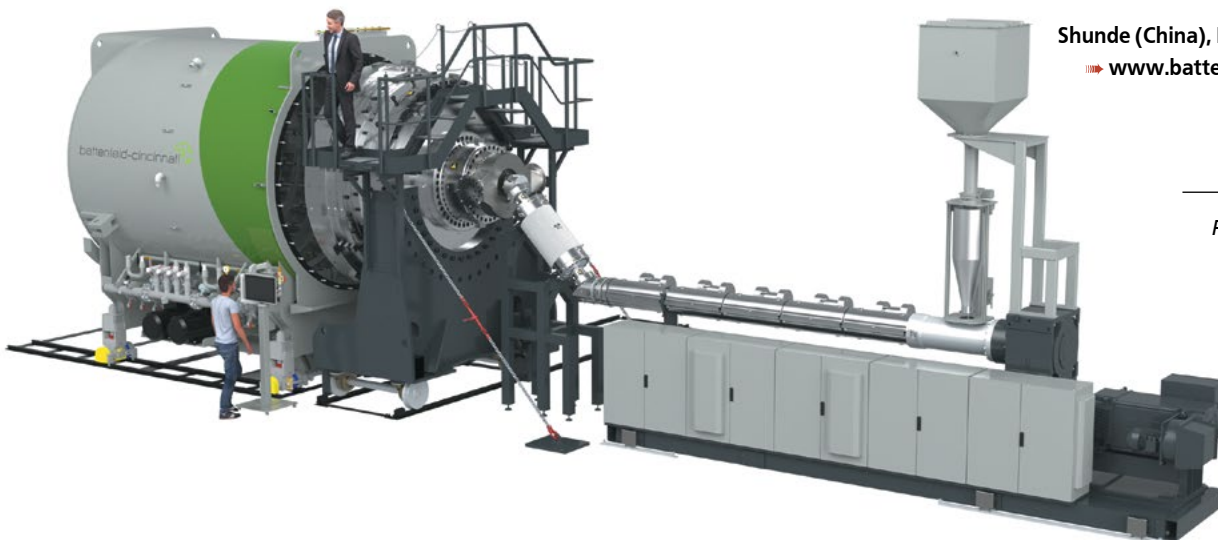

Revolutionizing Fiber Optic Infrastructure – *The Rise of Microduct Pipes*

In the era of rapid technological advancement, where connectivity is king, the demand for high-speed internet has never been greater. With this surge in demand comes the need for robust and efficient infrastructure to support it. Enter microduct pipes for optical fiber, a groundbreaking solution that is revolutionizing the telecommunications industry.

Microduct pipes are small, flexible conduits designed to house optical fibers, protecting them from environmental factors while facilitating easy installation and maintenance. Their compact size and flexibility make them ideal for various applications, from urban environments to rural areas, and even within buildings.

One of the key players in this burgeoning market is Tecnomatic, a company at the forefront of innovation in extrusion technology. Tecnomatic's groundbreaking lines, specifically engineered for microduct pipe production, have set new standards in terms of speed, efficiency, and quality.

At the heart of Tecnomatic's innovation lies its die-head, meticulously designed to achieve unprecedented production speeds. Capable of reaching up to 400 meters per minute for diameters of 7/3.5 and up to 200 meters per minute for diameters of 14/10, this die-head stands as a milestone in microduct pipe manufacturing.

The secret behind Tecnomatic's remarkable speed and precision lies in its innovative geometries, precise line adjustments, and profound understanding of the production process. By optimizing these factors, Tecnomatic has been able to push the boundaries of

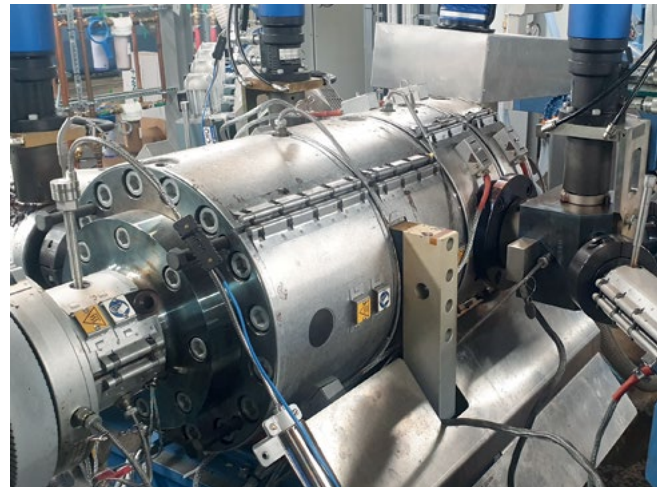

what was once thought possible, achieving production speeds that were previously unimaginable.

One of the most remarkable achievements of Tecnomatic's die-head is its ability to maintain impeccable sizing results even at such high speeds. With minimal tolerance and ovality, the microduct pipes produced are of the highest quality, meeting the stringent standards of the telecommunications industry.

Moreover, Tecnomatic's die-head is engineered for efficiency and flexibility, allowing for fast skin and colour changes with the adoption of special valves and multiple extruders. This feature not only enhances productivity but also enables manufacturers to meet the diverse needs of their customers with ease.

The implications of Tecnomatic's innovative die-head extend far beyond the realm of microduct pipe production. By enabling faster, more efficient manufacturing processes, it paves the way for accelerated deployment of fiber optic networks worldwide. This, in turn, translates to improved connectivity, economic growth, and quality of life for millions of people around the globe.

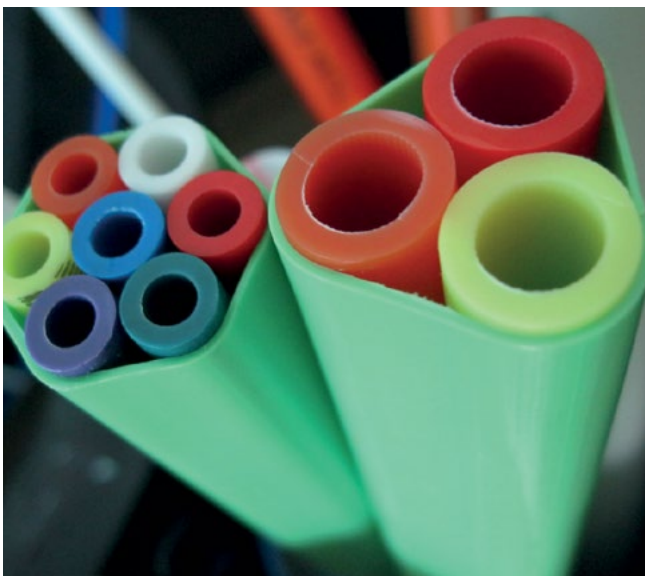

TECNOMATIC S.r.l.

Via Emilia, 4, 24052 Azzano S. Paolo (Bergamo), Italy

www.tecnomaticsrl.net

Sustainable Technology for the Rubber Industry Presented at DKT 2024

For more than 20 years, the extrusion specialist TROESTER has been offering its customers an extremely economical and gentle solution for high-quality applications with its ROTOMEX gear extruders, where strained rubber compounds ensure product quality.

Since the early 2000s, more than 150 ROTOMEX systems from the ZX75, ZX120 and ZX170 series have been supplied, which are used in the automotive, tire and pharmaceutical industry for the production of the finest technical rubber goods such as pharmaceutical products, sealing, profiles, hoses, curing bladders, windscreen wipers as well as compounds. The machines are rated for a compound throughput of 275 kg/h (ZX75), 760 kg/h (ZX120) and 1,400 kg/h (ZX170).

All ROTOMEX gear extruders are characterized by their simple and compact design, which means that they require an extremely small footprint and can be easily integrated into all production processes.

However, the most important advantage of a ROTOMEX is its extremely low energy input into the compound. Its energy consumption is up to 70% lower than that of a comparable single-screw extruder with a gear pump. This results in a specific energy requirement ≤ 45 Wh/kg.

In further comparison, a rubber compound can be plasticized with the ROTOMEX at a considerably lower

temperature rise without influencing the vulcanization kinetics, which ultimately ensures extremely gentle material treatment. In recent years, the straining of rubber compounds with the ROTOMEX has shown great success in extending the service life of rubber products. In several applications, the life cycles of curing bladders have been increased by up to 300%.

The ROTOMEX gear extruders can be seamlessly integrated into production processes, e.g. they can be placed upstream of an extruder or an injection molding machine and then feed the downstream equipment as required via an integrated product control loop.

TROESTER GmbH & Co KG

Am Brabrinke 1-4, 30519 Hannover, Germany

Karsten Jung, info@troester.de

www.troester.de

DKT 2024, Nürnberg/Germany (01.- 04.07.2024):

Booth 9-611, Hall 9

TROESTER Gear Extruder
ROTOMEX ZX Series



ProfilControl 7 Roughness Checks Quality of Rubber Compounds

A perfect rubber profile starts with a perfect compound. With the ProfilControl 7 Roughness inspection system from PIXARGUS it is possible to check the quality of rubber compounds in a straightforward, time-saving and efficient way.

The transformation of the rubber industry is in full swing. Companies have to become greener and strive to enhance the already high efficiency levels of their processes even further. The requirements on the raw materials and additions used in the production processes become more exacting every time. New types of fillers and additives have been appearing on the market. All this is happening in an environment of constantly rising cost pressure. With ProfilControl 7 Roughness from PIXARGUS, quality control of rubber compounds can be automated and integrated within the data network of the production facilities. As soon as the system says that the quality is good, the batch can be released for production.

No chance for defects and poorly mixed blends

The ProfilControl 7 Roughness system checks the quality by measuring the particle size distribution in the compound. The system features a special LED unit

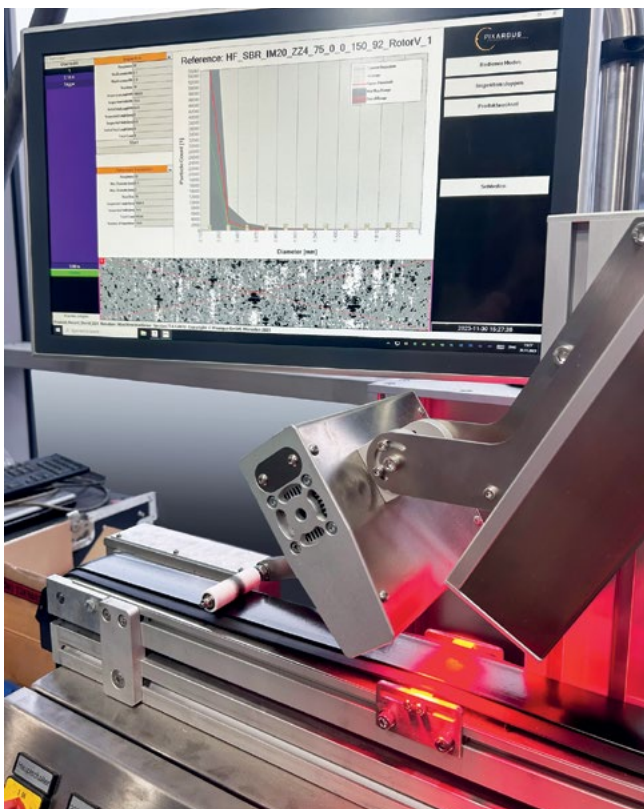

The Technical Center of the HF Mixing Group features two larger lab-scale mixing lines. For quality control, the compound mixing experts use inspection technology from PIXARGUS (Photos: HF Mixing Group)

that illuminates the test specimen of typically one meter length in such a way that the integrated high-resolution line scan camera can capture every detail of its entire surface. The images taken by the camera are evaluated by dedicated software in real time at a rate of approximately 100,000 particles per minute. The system triggers an alarm signal as soon as the size distribution is not as specified. Thus, it can reliably detect minute flaws down to just 20 μm in size.

Successfully in operation at HF Mixing Group

Mixing equipment specialist HF Mixing Group uses the ProfilControl 7 Roughness system in its Technical Center, the group's central technology lab, where they develop and test new machinery and automation solutions for

The PIXARGUS inspection system ProfilControl 7 Roughness checks the quality of rubber compounds by measuring the particle size distribution. It detects even extremely small flaws down to 20 μm in size. PIXARGUS' proprietary software evaluates the camera images in real time. From this evaluation, highly valuable quality data can be derived for the production process

compound mixing shops. The company's customers in the technological rubber products and global tire industries can use the fully automatic mixing lines installed in the lab to test their recipes at production scale.

Just recently, the group ordered a further inspection system from PIXARGUS. "The benefits of the system were compelling," says Ricarda Kendler, who is Head of the Technical Center & Process Engineering at HF Mixing Group. "To start with, the sample preparation is very easy and as many samples as desired can be continuously inspected 100%." Not less important is the fact that the PIXARGUS system can inspect both raw batches and final mixtures. "Most of the measuring methods available focus on the inspection of vulcanized samples. For us it is, however, crucial to be able to measure the quality ex the mixer, that is to say in the non-vulcanized state. We have no doubt that we can achieve this with the PIXARGUS system," emphasizes Kendler.

Enhanced quality data analysis for more process reliability

For lab environments, PIXARGUS supplies the Profil-Control 7 Roughness system as a compact smart version,

for mixing rooms as an inline system. The software of the systems, designed to operate within an integrated data network, provides a wide range of analysis functions. By relating the analysis data from the mixing room to the data acquired by the inspection systems checking the quality of the final product at the end of the production chain, it is possible, for example, to tell which compounds will produce optimum quality and which ones will result in out-of-spec production. "With this knowledge, we can make the production processes even more reliable for our customers," says Michael Frohn, Head of Sales at PIXARGUS.

PIXARGUS GmbH
Industriepark Aachener Kreuz,
Monnetstr. 2, 52146 Würselen, Germany
► www.pixargus.de

PIXARGUS, INC
10176 Intern. Boulevard, Cincinnati,
OH 45246, USA
► www.pixargus.com

Closed-Loop Recycling of HDPE – Pellets for Food Contact with OMNImax Recycling System

High-density polyethylene (HDPE) is widely used in the manufacture of bottles, pipes and containers because of its strength and rigidity, but also in personal care products, detergents and industrial fluids because of its durability. Another major application is the manufacture of bottle caps and milk bottles. A recycle stream already exists due to changes in deposit regulations and the attachment of bottle caps to the bottle. The caps go through the same washing systems as PET, are then separated in the float-sink tank and can be further processed. As a result, they also meet the high-quality requirements for bottle flakes.

Regrind from HDPE
bottle caps



If treated with the Gneuss "Super Clean Process", the regrind can be reprocessed back into a bottle cap, thus closing the recycling loop. The Gneuss OMNImax recycling system used in this process has undergone multiple challenge tests and has been awarded several food contact approvals/LNOs.

The technology does not require any upstream or downstream process steps. This is of great importance for polyethylene, as it can only be treated in other processes at very low temperatures and requires long residence times due to the slow diffusion processes involved.

The OMNImax purifies the polymer by subjecting it to highly efficient degassing using an MRSpure extruder

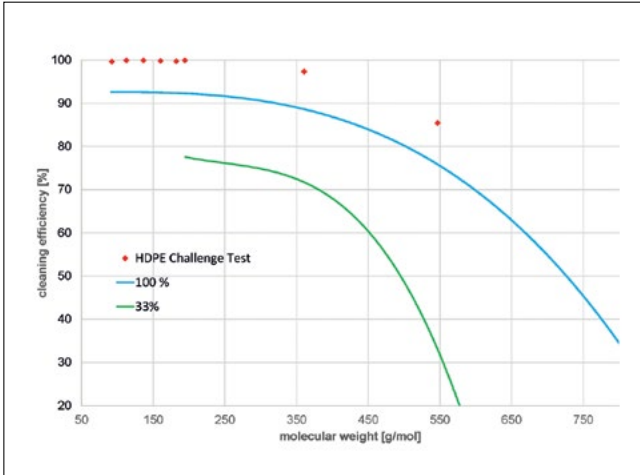

Results of the HDPE challenge tests, submitted 2024



for variations in the plastic waste to be processed in terms of moisture, contamination, viscosity, bulk density, etc. by adjusting the process parameters so that material of consistently high quality can be produced. Material changes, e.g. for batch changes, are possible within minutes due to the short residence time, so that the flexibility requirements of a new recycling plant are fully met, and production interruptions can be reduced to a minimum. This unique feature makes the OMNI^{max} recycling system exceptionally cost-effective, especially in applications where food contact or odor reduction is required.

In addition, the technologies developed and patented by Gneuss are characterized by:

- Compact design, small footprint
- Short residence time
- High flexibility
- Low energy consumption
- High economic efficiency
- High cleaning efficiency (super-clean), also for food contact

and a robust vacuum system to remove volatile contaminants. The Multi Rotation System (MRS) is preceded by a melt extruder, which separates the plasticizing and degassing/ deodorizing/ decontamination process steps so that the process parameters can be optimized individually for each process step.

Downstream of the melt extruder, the RSF^{genius} filtration system removes hard contaminants by ultra-fine filtration. Its fully automatic operation with guaranteed pressure and process consistency cleans the contaminated screens directly before they re-enter the melt channel, so that the screens can be automatically reused up to 400 times.

Typical filtration finenesses in HDPE recycling are 125 to 300 µm. In addition, for milk bottle recycling, the material can optionally be fed into the extruder via a 3C Rotary Feeder.

The flexibility of the recycling system is outstanding: the OMNI^{max} system compensates fully automatically

Gneuss Kunststofftechnik GmbH

Moenichhusen 42, 32549 Bad Oeynhausen, Germany

➔ www.gneuss.com

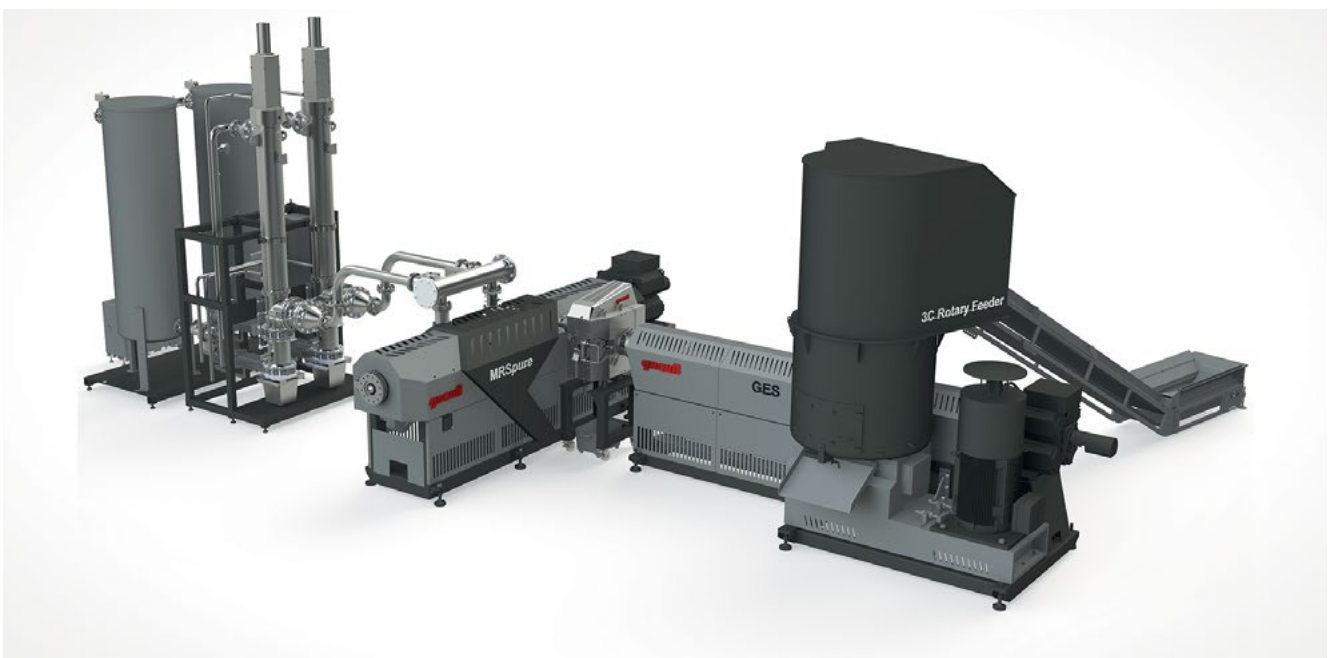

iQ STACK – Greater Efficiency Thanks to Automated Profile Handling

In the fast-moving world of industrial development, innovation is more important than ever – while Exelliq's iQ STACK is set to revolutionize profile extrusion: the elegant and ultramodern stacking system integrates seamlessly into existing extrusion lines and paves the way towards fully automated production process.

But what makes the iQ STACK so unique? With the iQ STACK, an automated stacking unit is positioned directly at the end of the extrusion line. This allows the profile bars to be automatically picked up after they have been cut to length and placed in the profile rack according to a desired stacking pattern. This innovative solution offers a number of advantages - from the independence from scarce personnel at the end of the line to the smooth transition from production directly into the warehouse. The focus is always on increasing added value.

The vision behind it

With its unique combination of precision, efficiency and versatility, the iQ STACK sets new standards in profile handling and opens up unexpected possibilities for companies to optimize their production processes. The iQ STACK is more than just a stacking system - it is the result of Exelliq's long-standing commitment to innovation and perfection in profile extrusion. With the aim of maximizing the efficiency of the extrusion process, the iQ STACK has been developed to open a new era of automation.

Profile handling made easy: automation and digitalization.

In the dawning age of digitalization, the iQ STACK is a living example of the fusion of extrusion process and

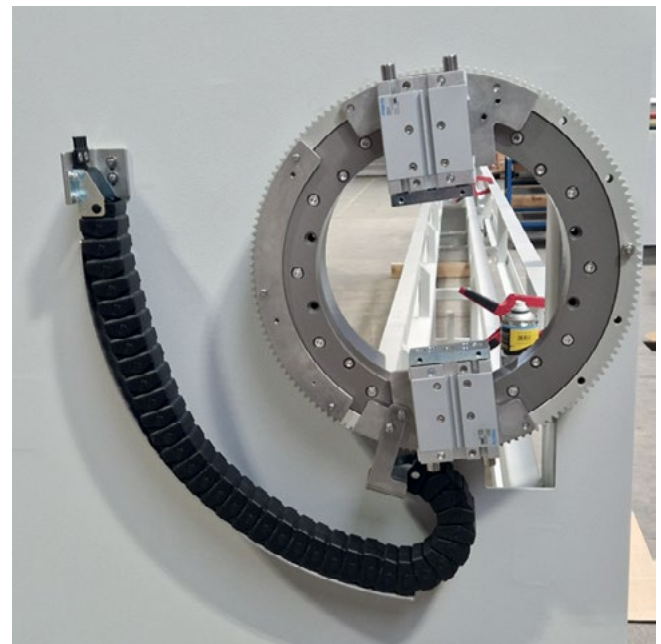

The turning unit rotates the profile bar into the desired position as needed (up to 180° depending on the stacking pattern)

automation. Being available 24 hours a day, 365 days a year, offers unrivalled reliability and maximum efficiency in production. The iQ STACK is an advanced solution and creates a solid foundation for future automation

Exelliq's iQ STACK paves the way towards a fully automated extrusion line.

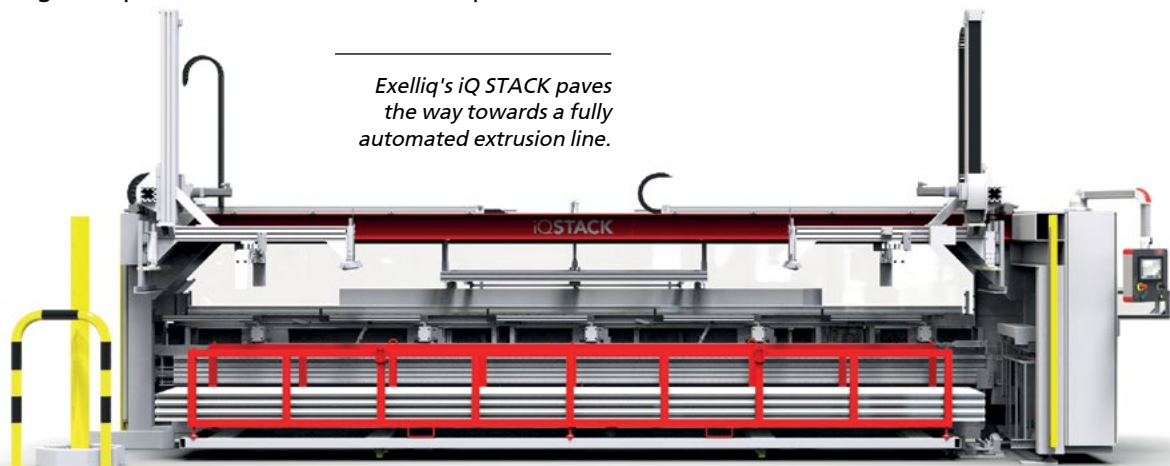



steps in the entire production and supply chain. The key to this is its sophisticated functionality: After a single profile bar has been cut off from the extrusion strand, it is guided into the machine in a controlled manner via a roller conveyor. The turning unit rotates it up to 180 degrees if needed. A pusher then moves the profile to the side onto the supporting arms (intermediate storage). This process is repeated until a layer of profiles has been completed on the supporting arms - the width of the layer corresponds to the width of the rack. Afterwards, the two gripper units pick up the entire layer, the supporting arms are swiveled out to the side and the profiles are placed in the rack. The gripper and supporting arms are lifted back to their original position to pick up the next layer of profiles. In this way, the transport rack is automatically filled layer by layer.

Features and technical details

- The profile length is set by manually positioning the gripper units and ranges from 4,500 to 6,500 mm. Optionally, an automatic length adjustment can be implemented and stored in the recipe, which allows a minimum profile length of 3,100 mm.
- The variable positioning of the gripper unit on both the inlet and outlet side makes it possible to place the profiles in a freely selectable position in the rack.
- The transport rack is fed in, centered and pushed out automatically.
- A non-visible infrared light grid not only supplies the necessary safety by permanently monitoring both the operating and outlet side, but also offers the best possible accessibility.

Seamless integration into the connected extrusion line with the proven DIGI.CONTROL

- The machine control is embedded in Exelliq's proven DIGI.CONTROL, which seamlessly integrates the iO STACK into the connected extrusion line.

Options

- Automatic insertion of separating strips (made of plastic or cardboard, length 630 to 700 mm, width 120 to 200 mm)
- Weighing of each profile bar
- Length measurement of each profile bar
- Optical quality control using a camera (gasket applied, film in the correct position, inner walls correspond to a reference image, ...)
- Scrap is automatically pushed to the non-operator side
- Ergonomic control panel on height-adjustable arm
- Remote maintenance via Webcam
- Service contract

Exelliq Austria GmbH
Friedrich-Schiedel-Str. 1,
4542 Nußbach, Austria
→ www.exelliq.com

New Solution for PVC Pipe Extrusion

In 2022, PVC accounted for 9.1% of the 58.7 million tonnes of plastics produced in the EU. Within the European community, the market for pipes for construction purposes recorded approximately 6.3 million tonnes of PVC, 60% of which consisted of rigid PVC pipes and 40% of flexible ones. As the latest Euroconstruct report shows, the construction sector in the last three years has recovered sharply in almost all Eurozone member states, with a growth rate of +2.1% calculated over the three-year period 2020 to 2023. Good news, therefore, for players specialising in the production and industrial processing of PVC, demand for which will continue to be positively influenced by recent investments in public and private construction.

The challenges of PVC pipe extrusion: production flexibility, parameter control, and reduction of setup times

The production of PVC pipes is characterised by numerous challenges: wide diameter range, pipe strength, consistent quality of the extruded output, and minimisation of waste. The performance of a line is therefore closely related not only to the optimisation of the individual extrusion process, but to the system's own ability to achieve high levels of production flexibility to meet the heterogeneous requirements of the various pipe applications.

Furthermore, the physical properties of PVC make the extrusion process particularly delicate. This polymer is in fact characterised by high thermal sensitivity and tends to degrade at temperatures as low as 180°C, a parameter close to its melting temperature. In this sense, in order to avoid compromising the quality of the output, it is necessary to limit the time it stays in the head. Once melted, the material proceeds into the barrel, so the main parameters to be controlled are barrel temperature, extruder flow rate, screw speed, pressure, and melt temperature.

With a view to increasing production flexibility and in light of the parameters to be met for the setup of an extrusion line, there is a need to reduce the setup time of extrusion plants. In the specific case of PVC pipes,

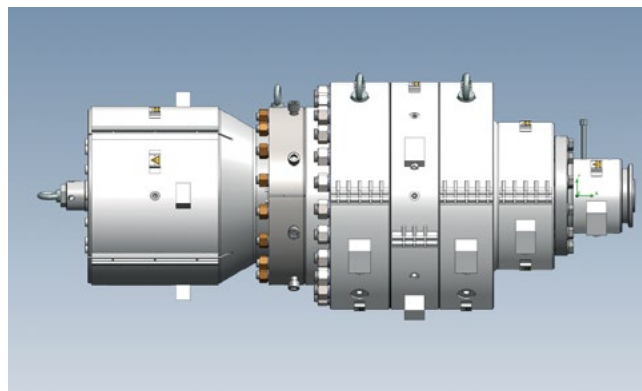

changing the diameter and thickness of the product requires a complex setup, characterised by horizontal fitting of new components, recalibration and adjustment of the configuration on the entire line, with an overall impact of 83 h/year of work not directly aimed at production.

Bausano changes the game: industry expertise that makes the difference

Bausano is meeting this challenge head on by developing an innovative PVC pipe head capable of covering a diameter range from 125 mm to 400 mm, with low flow rates (around 500 kg/h), preventing material degradation and excessive dwell times in a perfect balance between volume, flow rate, and production range.

As well as being compact in size, this unique Bausano solution reduces the number of heads from two to one, which has a positive impact on customers in terms of both overall investment and reduced mould setup times. In addition, the modular design of some parts of the head facilitates cleaning and maintenance for the operator during assembly and disassembly. The special head was then combined with an MD 92/30 Next-mover extruder without induction, featuring specially designed screws to process different dry blend formulations, from those containing the highest to those containing the lowest quantities of additives.

In terms of design, Bausano worked scientifically within very tight parameters in relation to both compression values and polymer dwell times. To achieve this, the collected information was initially processed using a Brabender plastograph. In detail, the starting materials were fed into the chamber, where they were heated and shear stresses were applied between two counter-rotating rotors. During this machining, the Design Team measured the torque applied to the rotating screws, thanks to which measurement it obtained information on the viscosity of the molten material and thus on any changes produced by machining on the system (gelation, branching, degradation).

The Team involved in the project then conducted an in-depth analysis of the rheological curves with the help of a capillary rheometer and fluid-dynamic simulation software in order to optimise the design of the new extrusion head and screws, accurately predicting the material's behaviour during the entire machining process.

Technological excellence, the result of the company's consolidated expertise in the design of custom extrusion systems: Bausano's novel solution features a multi-diameter head in C45 carbon steel, which is compact, modular, and chrome-plated in the surface where the material flows, and for the barrel and the nitrided screws. The latter, to be found in the S16 model, have been specially engineered to ensure high performance with different dry blend formulations. The line was also equipped with three volumetric dosing units, one for PVC, one stabiliser to prevent burns and one for the master, two reverse milling areas before degassing that increase and anticipate the feeding and gelling capac-

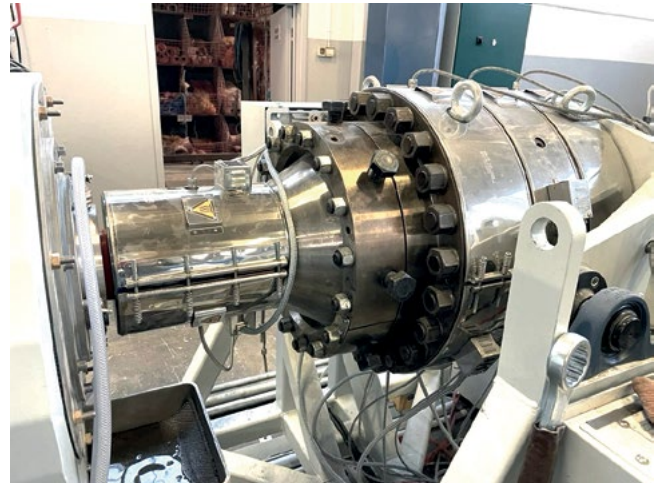

ity, and end-of-line with tank, ink-jet marker, haul-off unit, cutting unit and belling machine.

"The great challenge in terms of production efficiency, in the face of an increasingly diversified demand and tight delivery times, lies in being able to combine high variety and low production volumes, without compromising on quality," says Massimiliano Fenili, Bausano's Technical Manager, who concludes: "Bausano is committed to building plants with an OEE value close to 80%, so that Customers can be increasingly flexible, energy efficient, and with zero-waste production."

Bausano & Figli Spa
C.so Indipendenza 111,
10086 Rivarolo Canavese (TO), Italy
► www.bausano.com

Efficient Cable Recycling

Loacker Recycling based in Wonfurt, Germany, is part of the Loacker Recycling GmbH family business headquartered in Götzis, Austria, and specialises in waste cable recycling. Thanks to the recycling concept developed in-house, the company can achieve the highest possible copper recovery at low processing costs. The company trusts in Lindner's recycling expertise and uses a Polaris 2800 with rotor cooling.

The Loacker Group, based in Götzis, Vorarlberg (Austria), has been dedicated to collecting, sorting and processing valuable materials for over 100 years and is motivated by one thought: The best for the world of tomorrow. Family-owned for five generations, the group consists of a total of 25 companies and operates 47 sites in eight countries. The recycling plant in Wonfurt has been recovering end-of-life cables for decades. These mostly come from the DACH region and are largely



Shredding copper wire is a challenge in itself – but not with Lindner's Polaris. The electric universal shredder has a countershaft belt drive with flywheel energy storage and therefore sufficient power reserves for a consistent throughput

collected within the Loacker Group and delivered to Wonfurt for processing. The focus is on extracting pure materials to maximise the recyclables recovery.

Matthias Köhler has been Managing Director at the Wonfurt site since 2012. In recent years, a great deal of energy and expertise has been invested in expanding the recycling plant to achieve the best possible recycling results using the latest technology. In a three-shift operation, up to 100 tonnes of end-of-life cables are transformed into valuable recyclable materials every day. „We mainly recover copper from old cables, around 40 to 45 tonnes a day, but also PVC and ferrous metals. While the copper is turned into copper sheets in copper smelters, we deliver the PVC to a company located on site. There, the plastics are turned into barrier products. Ferrous metals are sent for metal processing. The way our plant is equipped, we achieve a particularly high degree of purity. That’s what makes us unique and gives us the ability to return almost 100% of the recycled material back into the cycle,” explains Matthias Köhler.

The Lindner Polaris 2800 with rotor cooling has been part of the plant at Loacker in Wonfurt since July 2023 and shreds copper cables to a final output size of <15 mm. „We are more than happy with the throughput rate and are particularly pleased that the shredder handles non-shreddables with ease, which do show up from time to time,” says Köhler happily. In buying a Polaris, a conscious decision was also made in favour of the screwable and quadruple-use blade cutting system. „We change the knives every seven to eight days, which is extremely easy thanks to the screwable system. It is also easy to access the rotor, knives and knife holders,” says Matthias Köhler. „Furthermore, the Polaris 2800 has the necessary drive power. Equipped with a countershaft drive and flywheel energy storage, the machine makes light work of shredding even difficult materials such as end-of-life cables with a high content of copper wire. The consistent throughput rate and high uptimes



Since July 2023, Lindner’s Polaris 2800 with an output of 5 tonnes per hour has been helping Loacker Recycling in Wonfurt to efficiently recycle end-of-life cables. Matthias Köhler, Managing Director of Loacker Recycling at the Wonfurt site since 2012, is more than happy with the output, maintenance and Lindner’s exceptional quality

„speak for themselves,” states Jan Rosenmeyer, Sales Manager at Lindner.

„We are extremely happy with the Polaris and would choose a Lindner shredder again. Output, rotor cooling and ease of maintenance convinced us. Using a Lindner, you also realise that the company has decades of experience in shredding technology. The overall package is just right,” adds Köhler.

Lindner-Recyclingtech GmbH
Manuel-Lindner-Str. 1, 9800 Spittal/Drau, Österreich
 ► www.lindner.com



Lindner’s Polaris 2800 is equipped with a cutting system consisting of blade knives that can be used 4 times. Knives and knife holders are easily accessible. The screwable system makes it easy to change the individual knives

Turkish Plastics Recycler Enters PET Bottle-to-Bottle Market

The plastics recycling company Tanrikulu based near Istanbul, Türkiye, commissioned its new Starlinger recoSTAR PET 215 iV+ bottle-to-bottle recycling system in the last quarter of 2023.

The PET bottle-to-bottle line is the second plastics recycling system from Starlinger that Tanrikulu has installed. It is in operation at Tanrikulu's post-consumer PET processing plant in Akyazi, Sakarya Province, in Türkiye's Marmara Region. The recycling system processes post-consumer PET bottle flakes and has a production output of 2.4 tons per hour. Tanrikulu supplies the bottle-grade rPET pellets to customers in Turkey and abroad.

The recoSTAR PET 215 iV+ recycling line is equipped with a special cartridge filter that reduces production waste, increases the production output and ensures highly purified melt. The backflush melt filter system called DPC 4000 operates continuously with two screen-bearing pistons and four screen cavities. With a total of approx. 4000 cm², the filtration area is 2.4 times larger than when using standard screens, filtering the melt with a fineness of 56 µm. Another big advantage is the high process stabilization as 75% of the filtration area is available in the filtration process during screen change and backflushing. The DPC 4000 cartridge filter significantly reduces melt loss during backflushing and generally improves system performance.

"With our ongoing investments in PET recycling we aim to protect our social, cultural and natural environment for future generations by closing the packaging loop. Every discarded PET bottle should become a new PET bottle again," said İzzet Tanrikulu, General Manager of Tanrikulu Group of Companies. "Starlinger is one of the leading technology suppliers in the field of PET bottle-to-bottle recycling. The Starlinger PET recycling process has been approved by international brand owners in the food and beverage sector as well as by important legal authorities such as FDA and EFSA. We strive to improve the environmental impact of plastic packaging by combining the latest technology with our vast experience in the field of recycling, thereby reducing both plastic waste and resource consumption."



Starlinger's recoSTAR PET 215 iV+ bottle-to-bottle recycling line installed at Tanrikulu's Akyazi plant in Sakarya Province, Türkiye, produces 2.4 tons of food-grade rPET pellets per hour (©Starlinger)

Starlinger recycling technology
Furtherstr. 47a, 2564 Weissenbach, Austria
www.recycling.starlinger.com

Tanrikulu Group
www.tanrikulu.com.tr/en/

Shredder Quartet Goes to the Netherlands

For the processing of post-consumer waste (PE) and flowerpots (PP), the Veolia Nederland subsidiary Aufderhaar Kunststof Recycling in Vroomshoop uses no less than four large WEIMA shredders for secondary shredding. The resulting regranulate is then reused for the production of packaging material.



Post-consumer waste before the recycling process

As part of Veolia Nederland B.V., Aufderhaar Kunststof Recycling B.V. has taken a firm place in the field of plastics recycling. Fifteen workers are employed in an area of approximately 11,000 m². The company mainly recycles polyethylene (PE) and polypropylene (PP). This includes plastic packaging materials and household waste as well as plastic flowerpots, most of which come from the Netherlands and Europe.

Performance and reliability in continuous operation

"When we recently decided on our fourth machine, the WEIMA W5.18 single-shaft shredder, we knew from our own experience that we wanted a reliable machine that would meet our high demands," says Sebastiaan Kok, production manager. "The rock-solid construction,

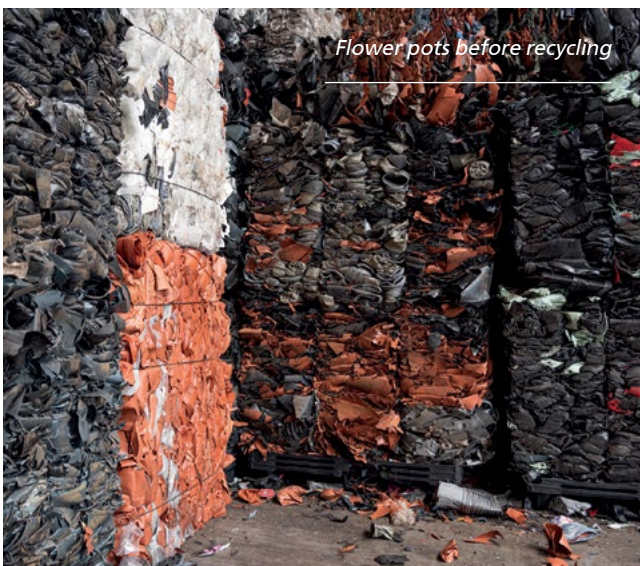

Flower pots before recycling



A WEIMA W5.18 single-shaft shredder shreds old flower pots



Shredding of plastic flower pots on a WEIMA shredder



Shredder quartet: The WEIMA W5.18 single-shaft shredder

together with the high performance of the drive, convinced us that this was the best choice for our requirements. And if maintenance is ever needed, the direct rotor access via a wide opening gives us plenty of space to work. This saves us valuable time."

All shredders within the four recycling lines are used continuously in this three-shift operation. They are filled with the help of wheel loaders that transport pre-shredded material into the large hopper openings of the WEIMA shredders around the clock. Aufderhaar changes the rotor blades every 250 hours, depending on the material, to ensure a consistently high throughput.

Loyalty pays off fourfold

The Dutch recycling expert can now call four WEIMA shredders its own. The first two plastic shredders were integrated into the production lines in 2018. The third followed two years later and finally the fourth in

2022. Further investments are already being planned. The most recent machine is used by Aufderhaar mainly for the preparation of polypropylene flowerpots. An innovation, as Sebastiaan Kok reports: "With the W5.18 shredder from WEIMA, we are now ideally positioned to carry out flowerpot recycling efficiently. After the pressed bales have been pre-shredded, the W5.18 shreds them to a homogeneous flake size. The built-in swing-arm pusher (we would say "swing ram" instead of "swing-arm pusher") presses the material against the rotor in a load-dependent manner. The flakes are then washed and extruded. We are very proud that we can contribute to the circular economy with our plants and that new, recycled products are created with the help of our work."

WEIMA Maschinenbau GmbH
 Bustadt 6-10, 74360 Ilsfeld, Germany
 ► www.weima.com

Recycling cycle of post-consumer plastics: raw material, flakes, & granules



Flower pot recycling cycle: raw material, flakes, & granules



“Our solutions optimize quality assurance – efficiently and sustainably”

In 2022, BST GmbH finally took the opportunity to once more present its latest quality-assurance solutions for web-processing industries at international exhibitions and interact with customers face to face. The company's products make a major contribution to efficient and resource-friendly production. In the interview below, Jörg Westphal (picture), executive vice president for the business unit Flexible Materials, explains how BST can help prevent waste, realize potential savings, and, with SMARTData, make quality-assurance processes even more sustainable.

Mr. Westphal, what BST solution are your customers especially interested in?

Jörg Westphal: The answer is without a doubt SMARTData, our contribution to the digitized optimization of inspection processes. SMARTData enables the collection, analysis and processing of quality-related data across all processes. The generated quality data is mutually compatible, allowing a multi-system, connected approach to quality.

What benefits does SMARTData provide for quality management?

Westphal: On the one hand, you get documentation of any kind of quality data for all processes. And on the other hand, thanks to the location-specific data allocation, rejects can be detected at an early stage and surgically removed from the production line, which provides extreme optimization of production efficiency. As a result, subsequent production processes are supplied with nothing but flawless materials, thus laying the groundwork for top product quality across the board – a major factor for reducing overall equipment costs. SMARTData optimizes processes and plays an important role in the predictive maintenance of machines and components.

What sort of changes have there been in the requirements



that your product solutions are expected to meet, and how is BST responding to those with its new products?

Westphal: Like everyone else, companies from the synthetics and rubber industry are having to adjust to the overall external conditions, which are in some cases challenging. As a result of the COVID-19 pandemic, for example, the shortage of skilled workers became even more noticeable. So it is very important that machines be easy to operate. No lengthy training or deep

technical know-how is needed for our product solutions. They are intuitive to operate and easily integrated into all of the common machines. At many companies, supply chains have also become more uncertain. So it is important to take the production material that you do have and use it as efficiently as possible. With our solutions, there is less scrap. So customers are saving not just material but energy as well, which is another increasingly important factor against the backdrop of the current energy crisis.



SMARTData

ADDED VALUE BY MULTIPLE CONNECTIVITY MEANS...

PERFECT RESULTS
LESS WASTE
MAXIMUM OVERALL EQUIPMENT EFFECTIVENESS

BST
member of **ELEXIS**^{repEd}

How is your company responding to the current challenges for global supply chains?

Westphal: Originally, our production operations were located in Bielefeld, and we shipped our products worldwide. Today, we are using our global production setup, and we are very proud of it. It makes us more independent of the uncertainties arising from global challenges while at the same time increasing efficiency and reducing costs. The decentralization of production also leads to shorter delivery distances and therefore fewer CO₂ emissions.

In addition to digitization, sustainability is one of the key issues of the future in the industry. How do BST solutions help customers achieve more resource-efficient production?

Westphal: Every system that we develop and produce for our customers makes a lasting contribution to the optimization of the value chain and makes production itself more sustainable: it reduces

scrap and makes it easy to see defects right away, so that they can be fixed quickly. Our technologies essentially aim to prevent waste: we want to not only signal savings potential but also ensure that waste is either not created in the first place or else is reusable with proper sorting. For that purpose, for example, there is the coding of synthetic materials, and that can be identified by our automated inspection systems. This reduces raw materials consumption and CO₂ emissions. With product features like this, we are making a clear contribution to climate protection.

How does BST make sure that quality doesn't suffer as a result of the use of recycled raw materials?

Westphal: Recycled materials are a very popular subject these days, and they are being used more and more often. Recycled plastic is different from freshly produced plastic in both its outward appearance and qualitative features. In other words, there are different qual-

ity grades involved. But there are also different requirements with respect to quality, and our systems are capable of automatically identifying the quality involved during the material inspection. As a result, products can be produced at the quality levels desired to match the requirements at any given time.

What is the most important issue facing the industry in the years ahead?

Westphal: Digitization, without a doubt. We are already very well positioned in that regard, and our customers are already profiting from SMARTData. But like much else having to do with digitization, this is a process that we are continually optimizing and refining, always for the benefit of our customers.

Thank you for this interview.

BST GmbH
Remusweg 1, 33729 Bielefeld, Germany
→ www.bst-gmbh.de

Perfect Conclusion to CHINAPLAS's Return to Shanghai

After a six-year hiatus, CHINAPLAS 2024 made a glorious return to Shanghai and concluded successfully on April 26 at the National Exhibition and Convention Center (NECC), Hongqiao, Shanghai, PR China.



The grand comeback to Shanghai immediately captured the attention of the global plastics and rubber industries with its immense scale and extraordinary appeal. The exhibition not only achieved a record-breaking number of exhibitors, with 4,495 companies participating from 38 countries and regions, occupying total exhibition area of 380,000 sqm, but also set a new record for visitor attendance. A total of 321,879 visitors from over 170 countries and regions attended the mega event, representing a 29.67% increase compared to the 2023 Shenzhen exhibition. Among them, the number of overseas visitors reached 73,204, accounting for 22.74% of the total, marking a significant growth of 157.50% compared to the 2023 Shenzhen exhibition.

"We have repeatedly broken records, surpassing the number of exhibitors, total visitor count, and overseas visitor count of any previous edition of CHINAPLAS. The outcome is both expected and unexpected. As the exhibition returned to Eastern China after six years, various aspects such as the lively atmosphere, highlights of innovative technologies, the quantity and quality of visitors, and the proportion of overseas buyers have all significantly exceeded expectations," said Ada Leung, General Manager of Adsale Exhibition Services Ltd., the organizer of CHINAPLAS. "As the plastics and rub-

ber industries move towards high-quality development, CHINAPLAS is also running on the path of high-quality growth. Renowned exhibitors from around the world showcased their innovative products, demonstrating the "New Productive Forces" whereas local and international buyers with strong purchasing power come together in the two-way journey. Placing orders, signing contracts, delivering good news, engaging in face-to-face discussions on technological innovations, and unleashing industry opportunities have become the norm at the exhibition. The satisfaction of exhibitors and visitors with the effectiveness of the exhibition has substantially increased."

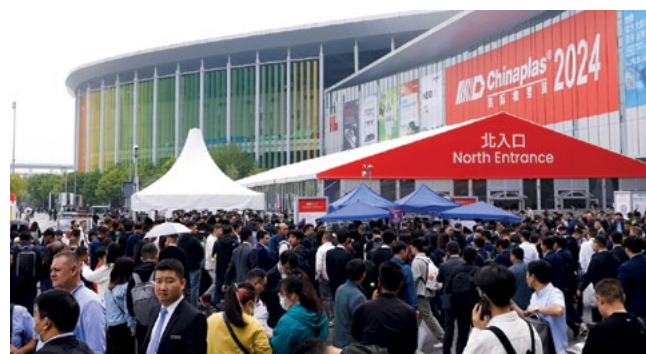



Focusing on the four main themes of "Circular Economy," "Innovative Materials," "Digitalization" and "High-End Technologies from China," the exhibition showcased innovative technologies presented by global exhibitors. It highlighted keywords such as carbon reduction, energy efficiency, cost reduction, intelligence, efficiency and high quality, directly addressing customer pain points and demands, and getting a lot of attentions in the fairground.

The wave of sustainability is sweeping across the globe. Many exhibitors dedicated their efforts to the realm of "Circular Economy" and "Sustainability." They introduced various innovative achievements, including bio-based plastics and biodegradable plastics with exceptional performance, single-material solutions, post-consumer recycled polycarbonate, chemically recycled medical-grade ABS materials and additives to enhance the performance of recycled plastics, carbon capture technologies, 100% recyclable closed-loop production lines for bottle caps, and online granulating recycling technologies. These innovations related to the circular economy were richly presented at CHINAPLAS 2024, fostering deep exploration and collaboration within the industry.

Innovative materials were underlined at the exhibition. There was a wide range of materials for photovoltaic storage charging applications, such as ETFE films that enhance the power generation efficiency of photovoltaic modules, photovoltaic adhesives, photovoltaic back sheets, photovoltaic energy storage solutions, and fast-charging materials. The exhibition also witnessed a significant increase in solutions related to fuel cell stacks, hydrogen production, and hydrogen storage, providing

strong support for the green transformation of energy. The application of lightweight, flame-retardant, and thermal management materials for new energy vehicles (NEV) continued to advance. High-strength plastics and composite materials demonstrated their capabilities in the emerging low-altitude economy.

As visitors walked through the exhibition halls, the presence of robotic arms swinging and flipping, skillfully grasping components, caught the eyes. The booths showcasing automated and unmanned high-efficiency production became a focal point for visitors, drawing crowds both inside and outside. Cutting-edge technologies take center stage, such as smart high-speed rotogravure printing machines, all-electric high-performance injection molding machines, precision molding of optical lens, one-shot process for injection molding and painting with high-gloss surfaces, robot automatic tool changers, AI bottle chip sorting systems, layered injection moulding and automation for moulded optical lens, solutions for the molding and packaging of 384-channel medical pipette heads, MES digital smart management systems, etc. These demonstrations in the realm of "Digitalization" vividly embodied the innovation and excitement within the plastics and rubber industries.

As industry insiders immersed themselves in the visually stunning experiences, they were also treated to a series of captivating auditory delights. The exhibition featured a wide range of exciting concurrent events and activities, namely The World Trends and Plastics and Rubber Technology Summit, Plastics Recycling & Circular Economy Conference and Showcase, Tech Talk, Medical Plastics Connect, Application in Focus, The Innovation of Injection Molding Forum, Empowering Product Quality with Advanced Moulding & Innovative Technology Symposium 2024, Product Innovation Gallery, Market Insights Hub, etc which have drawn large crowds, bringing a vibrant and engaging experience to all participants.

The next edition CHINAPLAS 2025 will be held at Shenzhen World Exhibition & Convention Center (Bao'an), Shenzhen, PR China on April 15-18, 2025.

For more information or enquiries about the show, please visit:

► www.ChinaplasOnline.com
Chinaplas.pr@adsale.com.hk



Successful Trade Fair Conclusion

Both innovative machines and cutting-edge raw materials were sold at the four-day Plastpol – plastics processing exhibition at Targi Kielce, Poland. The contract for the regranulate supply was signed by the Polish ML Polyolefins and the German Keeper group.

The International Fair of Plastics and Rubber Processing PLASTPOL has advanced to become one of the most important events in Europe's plastics processing and rubber business sector. The 28th Targi Kielce expo brings together over 600 companies from 31 countries, mainly from Europe, Asia and the Middle East.

"From the first day we hosted thousands of visitors; innovative technologies have generated the most avid interest. Exhibitors have indicated energy efficiency as the top-ranking aspect to which customers pay the most attention. The machines that save up to 30, 40 or 50 percent of energy compared to standard machines are in great demand," reports Andrzej Mochoń, president of the Kielce exhibition and congress centre.

Raw materials which serve the environment are contracted in Kielce

Critical product selection criteria are also related to the sustainable development of companies. The Polish Bedeko signed agreements for the sale of bio line components. Many talks conducted by the German Kraiburg TPE, a producer of TPE compounds for the automotive, consumer products, industrial and medical sectors, have been successfully completed.

The agreement on the industry's sustainable development was signed by Polish ML Polyolefins, i.e. Central and Eastern Europe's largest producer of PP regranulate, and one of the leading European suppliers of plastic products for households, Keeper Group established cooperation. The contract stipulates the supply of approximately 2,000 tons of recyclate per year. As both parties emphasise, this cooperation is the result of striving for sustainable development not only in the plastics processing industry, but also in the sectors using plastics, such as trade. "We keep increasing the basket pro-



duction using circular materials. Box baskets produced with regranulate added will be delivered to retail chains in many European countries," says Grzegorz Kicerman, president of the Keeper company. – Our customers expect goods produced from recyclate,

"We are ready to supply the highest quality regranulate, also for the production of food packaging; we keep waiting for the European Commission's action," explained Krzysztof Nowosielski, commercial director at ML Polyolefins.

"We expect to finalise a few more agreements. Many more leads will surely bear fruit after the Expo," recapitulates Kamil Perz, Plastpol project director.

Targi Kielce

➔ www.targikielce.pl, www.kielcekonferencje.pl
➔ <https://www.targikielce.pl/en/plastpol>

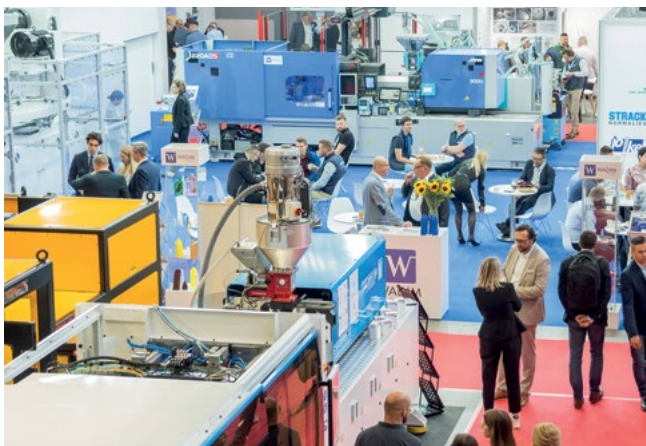

SMART EXTRUSION

**THE SPECIALIZED WEBPORTAL
ON EXTRUSION
FOR EVERY MODERN NEED**



VM Verlag GmbH
Cologne, Germany



www.smart-extrusion.com

EXTRUSION

EXPERT MAGAZINE ON PLASTICS EXTRUSION

The only technical magazine worldwide exclusively for the sectors:

- Material Preparation
- Compounding
- Extrusion
- Recycling
- Calendering
- Thermoforming
- Welding
- Finishing of Plastics and Elastomers



Extrusion (German)

Extrusion International (English)

Extrusion International USA (English)

Extrusion Asia Edition (Mandarin/English)

The only plastics trade magazine for Asia, published from Germany

8 issues a year

6 issues a year

6 issues a year

2 issues a year

**SMART
EXTRUSION**

All editions available for free:

www.smart-extrusion.com

VA Verlag GmbH Cologne/Germany

